

Series CA9 Contactors

NEW

CA9 Contactors

The modern contactor for demanding applications up to 900HP (@460V) - up to 1150HP (@ 575V)

Sprecher + Schuh's CA9 contactor line combines the simple function of our popular CA7 series with the rugged performance demanded in this wide horsepower range. CA9 contactors offer a smaller footprint than traditional contactors in this size class.

A broad selection for middle horsepower applications

The CA9 range consists of sixteen contactors in six frame sizes covering motors from 75 to 900HP at 460V and from 100 to 1150HP at 575V. This line is ideally suited for demanding applications such as steel mills, rock quarries, mines or for any middle horsepower application where a sturdy, durable contactor is needed.



Rugged and reliable

CA9 contactors conform to UL508, IEC 60947 and can be operated at rated voltages up to 600V (UL) and 1000V (IEC). High thermal and switching capacities guarantee reliable operation and long life.

Arc quenching extends contact life

All CA9 contactors are designed with sophisticated arc quenching techniques that extinguish damaging breaking arcs quickly. This is accomplished by guiding the arc away from the contacts and into "arc chambers", which are built-in to every CA9 cover.

Safety first

CA9 arc chambers are completely enclosed (without arc exhaust vents), offering the best protection against hot arcing gases. A large safety distance in front of the contactor is unnecessary. CA9 contactors are also de-

signed so that operation is impossible if the arc chambers are removed. Conversely, once the contactor is energized, the arc chambers cannot be removed.

Electronic coils offer many advantages

Behind the attractive outward appearance of the CA9 contactor are advanced engineering solutions that offer convenience and savings. The entire line is equipped with an electronically controlled coil that reduces pick-up currents by 80% on average. Holding current is also reduced.

Other advantages of the CA9 electronic coil include:

- Direct connection to a PLC. This is a standard feature in larger amp units and optional below 400A.
- Overvoltage protection and suppression circuits are standard, eliminating interference from the coil
- Smooth, even operation over the entire voltage range minimizes the possibility of contact bounce
- No safeguards are necessary to bridge brief supply interruptions
- Precisely defined pick-up and drop-out voltages, eliminate the possibility of chattering
- Universal Electronic coils operate over a much broader AC/DC voltage range, providing flexibility in applications and lower costs due to reduced inventory. Four coils cover six contactor frame sizes from 24-500V AC and 24-500V DC.

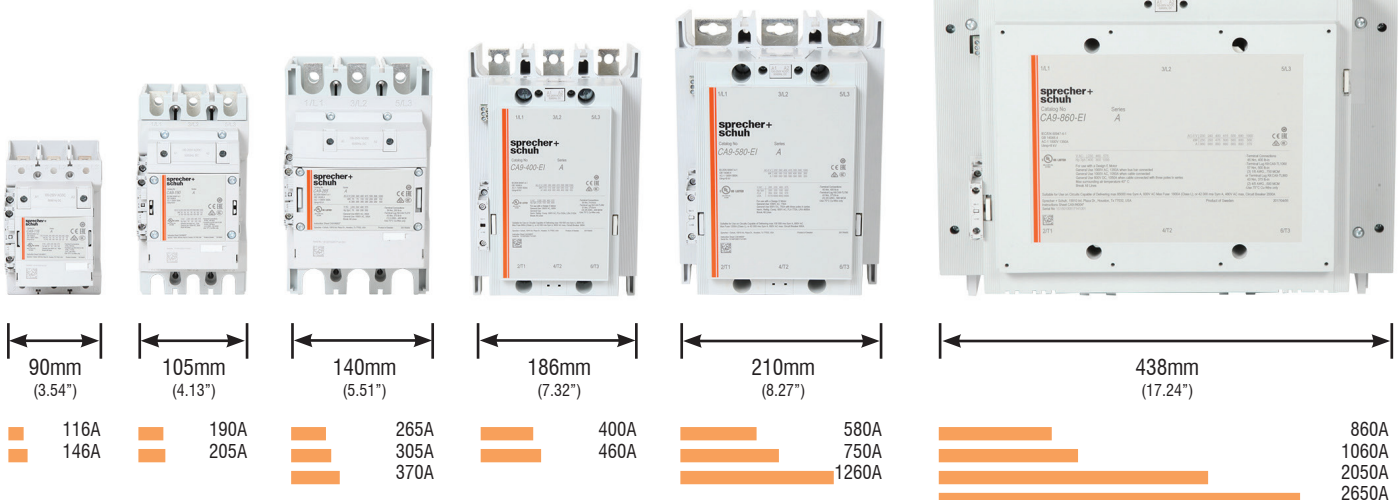

Non-Reversing, Three Pole Contactors With AC/DC Coil, Series CA9 (Open type only) ①②

I _e [A]		Ratings for Switching AC Motors (AC2 / AC3)												Auxiliary Contacts per Contactor		Open Type
		kW (50 Hz)								UL/CSA HP (60 Hz)						
		AC-3 (400V)	AC-1 (690V)	220-240V	380-400V	415V	440V	500V	690V	1000V	3 Ø					
116	160	37	55	55	75	75	63	55	30	40	75	100	1	1	CA9-116-11-* CA9-116-EI-11-*	
146	225	45	75	75	90	90	90	75	40	50	100	125	1	1	CA9-146-11-* CA9-146-EI-11-*	
190	275	55	90	90	110	110	132	110	50	60	125	150	1	1	CA9-190-11-* CA9-190-EI-11-*	
205	350	55	110	110	132	132	160	132	60	75	150	200	1	1	CA9-205-11-* CA9-205-EI-11-*	
265	400	75	132	132	160	160	200	160	75	100	200	250	1	1	CA9-265-11-* CA9-265-EI-11-*	
305	500	90	160	160	160	200	250	185	100	125	250	300	1	1	CA9-305-11-* CA9-305-EI-11-*	
370	600	110	200	200	200	250	315	200	125	150	300	350	1	1	CA9-370-11-* CA9-370-EI-11-*	
400	600	110	200	220	220	250	315	220	125	150	350	400	1	1	CA9-400-EI-11-*	
460	700	132	250	250	250	315	355	280	150	200	400	500	1	1	CA9-460-EI-11-*	
580	800	160	315	355	355	400	500	355	200	250	500	600	1	1	CA9-580-EI-11-*	
750	1050	220	400	425	450	530	600	400	250	300	600	700	1	1	CA9-750-EI-11-*	
860	1350	250	475	500	560	630	800	555	~	400	800	1000	1	1	CA9-860-EI-11-*	
1060	1650	315	560	630	710	710	1000	600	~	450	900	1150	1	1	CA9-1060-EI-11-*	
~	1260	~	~	~	~	~	~	~	~	~	~	~	1	1	CA9-1260-EI-11-*	
~	2050	~	~	~	~	~	~	~	~	~	~	~	1	1	CA9-2050-EI-11-*	
~	2650	~	~	~	~	~	~	~	~	~	~	~	1	1	CA9-2650-EI-11-*	



CA9-116 contactor



CA9-400-EI contactor



CA9-860-EI contactor

CA9-_-EI coils are electronically controlled coils with the following characteristics:

- Ability to connect directly to a low level signal source such as a PLC ~15VDC (6mA) to 33VDC (20mA)
- Very low pull-in and holding current for contactors in this size class
- Threshold voltages for pull-in and drop-out are very precisely defined, eliminating "chattering"
- Supply voltage dips are bridged without extra equipment

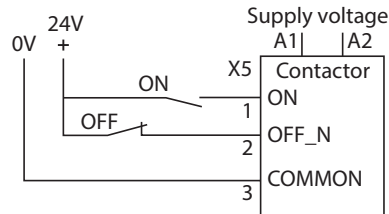

PLC Interface "EI" connection

Coil Codes

Electronic Coils	V	24-60V	48-130V	100-250V	250-500V
CA9-116...370	AC/DC	24W	48W	120W	480W
CA9-116-EI...370-EI	AC/DC with PLC Input	~	~	120W	480W
CA9-400-EI...750-EI		24W ④	48W	120W	480W
CA9-860-EI...1060-EI		~	~	120W	~
CA9-1260-EI		24W ④	48W	120W	480W
CA9-2050-EI...2650-EI		~	~	120W	~

Note: CA9-190...2650 open-type contactors include terminal bolts. If lugs are required, see page A94 for ordering information.

Ordering Instructions

Specify Catalog Number	
Replace (*) with Coil Code	See Coil Codes on this page

- ① "-EI" designates contactor coil with PLC input. Selections CA9-116...370 with "EI" requires use of control logic on terminals 1, 2, 3. CA9-400 contactors and larger include an integral switch to select use of "EI".
- ② CA9-116(-EI)...146(-EI) include terminal lugs. To order with terminal bolts remove the letter "-L" at the end of the catalog number. For example CA9-116(-EI)-*-11-L becomes CA9-116(-EI)-*-11.
- ③ For UL/CSA Elevator duty rating, consult Technical Information on page A103.
- ④ Coil is rated 24V...60V DC only.

Reversing, Three Pole Contactors With AC/DC Coil, Series CA9 (Open type only) ①②

I _e [A]		Ratings for Switching AC Motors (AC2 / AC3)												Auxiliary Contacts per Contactor		Open Type	
		kW (50 Hz)								UL/CSA HP (60 Hz)							
AC-3 (400V)	AC-1 (690V)	220-240V	380-400V	415V	440V	500V	690V	1000V	3 Ø				NO	NC	Catalog Number		
116	160	37	55	55	75	75	63	55	30	40	75	100	1	1	CAU9-116-22-* L ⑥ CAU9-116-EI-22-* L ⑥		
146	225	45	75	75	90	90	90	75	40	50	100	125	1	1	CAU9-146-22-* L ⑥ CAU9-146-EI-22-* L ⑥		
190	275	55	90	90	110	110	132	110	50	60	125	150	1	1	CAU9-190-22-* CAU9-190-EI-22-*		
205	350	55	110	110	132	132	160	132	60	75	150	200	1	1	CAU9-205-22-* CAU9-205-EI-22-*		
265	400	75	132	132	160	160	200	160	75	100	200	250	1	1	CAU9-265-22-* CAU9-265-EI-22-*		
305	500	90	160	160	160	200	250	185	100	125	250	300	1	1	CAU9-305-22-* CAU9-305-EI-22-*		
370	600	110	200	200	200	250	315	200	125	150	300	350	1	1	CAU9-370-22-* CAU9-370-EI-22-*		
400	600	110	200	220	220	250	315	220	125	150	350	400	1	1	CAU9-400-EI-22-*		
460	700	132	250	250	250	315	355	280	150	200	400	500	1	1	CAU9-460-EI-22-*		
580	800	160	315	355	355	400	500	355	200	250	500	600	1	1	CAU9-580-EI-22-*		
750	1050	220	400	425	450	530	600	400	250	300	600	700	1	1	CAU9-750-EI-22-*		



CAU9-190 Reversing Contactor

Includes:

- Mechanical and electrical Interlock
- Reversing power wiring (using Power Wiring Kit Cat.# CA9-PW...) ⑤
- Mounting plate (when required)
- Control wiring available; see footnote ④

Larger sizes are possible. Contact your Sprecher + Schuh representative.

CA9-...EI coils are electronically controlled coils with the following characteristics:

- Ability to connect directly to a low level signal source such as a PLC ~15VDC (6mA) to 33VDC (20mA)
- Very low pull-in and holding current for contactors in this size class
- Threshold voltages for pull-in and drop-out are very precisely defined, eliminating "chattering"
- Supply voltage dips are bridged without extra equipment

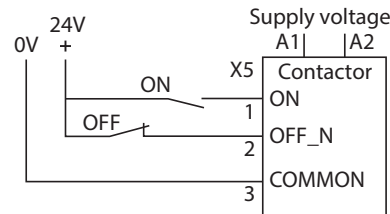

PLC Interface "EI" connection

Coil Codes

Electronic Coils	V	24-60V	48-130V	100-250V	250-500V
CA9-116...370	AC/DC	24W	48W	120W	480W
CA9-116-EI...370-EI	AC/DC with PLC Input	~	~	120W	480W
CA9-400-EI...750-EI		24W ⑤	48W	120W	480W
CA9-860-EI...1060-EI		~	~	120W	~
CA9-1260-EI		24W ⑤	48W	120W	480W
CA9-2050-EI...2650-EI		~	~	120W	~

Note: CA9-190...2650 open-type contactors include terminal bolts. If lugs are required, see page A94 for ordering information.

Ordering Instructions

Specify Catalog Number	
Replace (*) with Coil Code	See Coil Codes on this page

- ① "-EI" designates contactor coil with PLC input. Selections CA9-116...370 with "EI" requires use of control logic on terminals 1, 2, 3. CA9-400 contactors and larger include an integral switch to select use of "EI".
- ② For UL/CSA Elevator duty rating, consult Technical Information on page A103.
- ③ For Reversing Contactors *without* power wiring add suffix "**LW**" to catalog number. For example: CAU9-116-22-* becomes CAU9-116-22-***LW**. Control wiring is not included.
- ④ For control wiring, add suffix **-CW** to catalog number. For example: CAU9-116-22-* becomes CAU9-116-22-***CW**.
- ⑤ Coil is rated 24V...60V DC only.
- ⑥ CAU9-116(-EI)...146(-EI) include terminal lugs. To order with terminal bolts remove the letter "**L**" at the end of the catalog number. For example CAU9-116(-EI)-22-***L** becomes CAU9-116(-EI)-22-*.

Hydraulic Elevator Wye Delta, with AC Coils (Two Contactor Type ①)

UL/CSA ELEVATOR DUTY				Auxiliary Contacts per Contactor		Open Type
200V	230V	460V	575V	NO	NC ②	Catalog No.
54 15	54 20	54 40	54 50	1	1	CA9Y2-116-22-* LW ⑤ CA9Y2-116-EI-22-* LW ⑤
54 15	54 20	54 40	54 50	1	1	CA9Y2-146-22-* LW ⑤ CA9Y2-146-EI-22-* LW ⑤
77 20	77 25	77 60	77 75	1	1	CA9Y2-190-22-* LW CA9Y2-190-EI-22-* LW
99 30	99 30	99 75	99 100	1	1	CA9Y2-205-22-* LW CA9Y2-205-EI-22-* LW
125 40	125 40	125 100	125 125	1	1	CA9Y2-265-22-* LW CA9Y2-265-EI-22-* LW
149 40	149 50	149 100	149 150	1	1	CA9Y2-305-22-* LW CA9Y2-305-EI-22-* LW
156 50	156 60	156 125	156 150	1	1	CA9Y2-370-22-* LW CA9Y2-370-EI-22-* LW

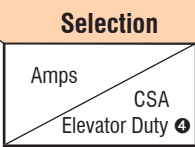

CA9Y2-116 Wye-Delta contactor

Includes:

- Mechanical and electrical Interlocks ②
- Mounting plate

CA9 “EI” coils are electronically controlled coils with the following characteristics:

- Ability to connect directly to a low level signal source such as a PLC ~15VDC (6mA) to 33 VDC (20mA)
- Very low pull-in and holding current for contactors in this size class
- Threshold voltages for pull-in and drop-out are very precisely defined, eliminating “chattering”
- Supply voltage dips are bridged without extra equipment

Coil Codes

Electronic Coils	V	24-60V	48-130V	100-250V	250-500V
CA9-116...370	AC/DC	24W	48W	120W	480W
CA9-116-EI...370-EI	AC/DC with PLC Input	~	~	120W	480W

Ordering Instructions

Specify Catalog Number	
Replace (*) with Coil Code	See Coil Codes on this page.

- ① “EI” designates contactor coil with PLC input. Selections CA9-116...370 with “EI” requires use of control logic on terminals 1, 2, 3. CA9-400 contactors and larger include an integral switch to select use of “EI”.
- ② One NC auxiliary contact on each contactor is used for electrical interlocking.
- ③ Other voltages available, see page A96.
- ④ HP selection based on CSA Elevator Duty Ratings.
- ⑤ CA9Y2-116(-EI)...146(-EI) include terminal lugs.

Auxiliary Contact Blocks

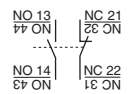
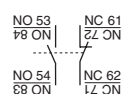
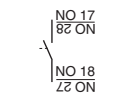
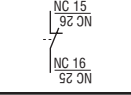
Auxiliary Contact Blocks	Description	NO	NC	Contact Arrangement	For use with...	Catalog Number
	Auxiliary Contact Block for Side Mounting <ul style="list-style-type: none"> • 2-Pole • Two-way numbering for right or left mounting • Easy mounting without tools • Mirror contact performance to main contactor poles • Low power switching down to 24V 50mA 	1	1		CA9-116...370 Inside left or right	CA9-S1-11
					CA9-400...2650 Inside left or right	CA9-S3-11
	1	1		CA9-116...370 Outside left or right	CA9-S2-11	
				CA9-400...2650 Outside left or right	CA9-S4-11	
	1	0		CA9-116...370 Inside left or right	CA9-S1-B10 ①	
				CA9-400...2650 Inside left or right	CA9-S3-B10 ①	
0	1		CA9-116...370 Inside left or right	CA9-S1-B01 ①		
			CA9-400...2650 Inside left or right	CA9-S3-B01 ①		

NOTE: Up to four auxiliary contact blocks (8 poles) may be mounted on the side of the CA9 contactor. One auxiliary contact block (1 NO + 1 NC) is mounted at the factory (inside left position).

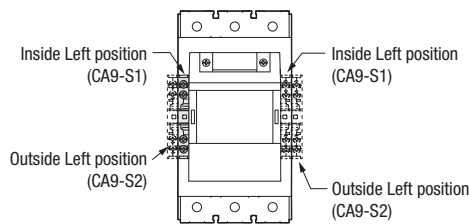

CA9-116...370

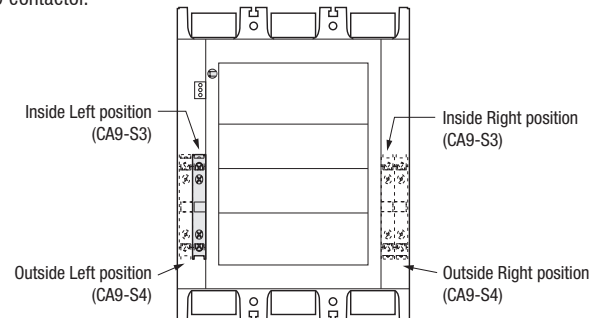

CA9-400...2650

Mechanical Interlocks

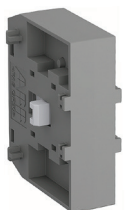
Accessory	Description	For use with...	Catalog Number
	<ul style="list-style-type: none"> • Mechanical only, without auxiliary contacts • Interlocking of two same size contactors 	CA9-116...CA9-370	CA9-M1-00
		CA9-400...750, CA9-1260 ②	CA9-M2-00
		CA9-860...1060, CA9-2050...2650 ③	CA9-M3-00
	<ul style="list-style-type: none"> • Mechanical only, without auxiliary contacts 	CA9-116...146 to CA9-190...205	CA9-M4-00
		CA9-190...205 to CA9-265...370	CA9-M5-00
<ul style="list-style-type: none"> • Rod for vertical mounting reversing contactors 	CA9-400...750	CA9-VR750	

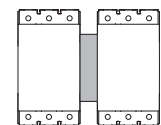

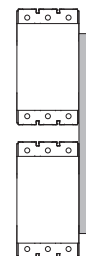

Horizontal mechanical interlock CA9-M_00



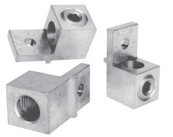
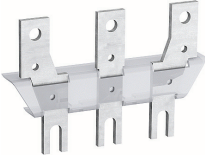

Vertical mechanical interlock CA9-VR750

- ① Contact blocks cannot be mounted on the outside of CA9-S1-B* or CA9-S3-B*.
- ② Mounting plate ordered separately.
- ③ Mounting plate included.

Terminal Lugs and Accessories

Lug or Accessory	Connection	Wire Sizes	For use with...	Catalog Number
 <p>Order 1 Pkg for 2 kits</p>	Terminal Lug Kit - <ul style="list-style-type: none"> Standard for CA9-116-_-L...146-_-L Includes 2 sets, one for Line side and one for Load Side 	2 x 6 AWG...3/0 AWG	CA9-116(-EI)...146(-EI)	CA9-CL146
 <p>Order 1 Pkg for 3 lugs</p>	Terminal Lugs ① <ul style="list-style-type: none"> Includes 1 set of 3 lugs for use on either Line or Load Side. Order qty of 2 for both. 	6 AWG...300 MCM	CA9-190(-EI)...205(-EI)	CA9-TL205
		4 AWG...400 MCM	CA9-265(-EI)...370(-EI)	CA9-TL370
		2 x 4 AWG...500 MCM	CA9-265(-EI)...370(-EI)	CA9-TL370B
		3 x 2/0 AWG...500 MCM	CA9-400-EI...460-EI	CA9-TL580
		2 x 2/0 AWG...500 MCM	CA9-580-EI...750-EI	CA9-TL750
		4 x 4/0 AWG...500 MCM	CA9-860-EI	CA9-TL860
		4 x 1/0 AWG...750 MCM	CA9-1060-EI	CA9-TL1060
	Terminal Enlargements <ul style="list-style-type: none"> Enlargement pieces designed to increase the width of the contactor terminal pads in order to allow larger connections to be mounted 		CA9-116(-EI)...146(-EI)	CA9-TE146
			CA9-190(-EI)...205(-EI)	CA9-TE205
			CA9-265(-EI)...370(-EI)	CA9-TE370
			CA9-400-EI...460-EI	CA9-TE460
			CA9-580-EI...750-EI	CA9-TE750
			CA9-1260-EI	CA9-TE1260
	Terminal Extensions <ul style="list-style-type: none"> Extension pieces designed to extend the main terminals of contactors for combined mounting of contactors and connection sets 		CA9-116(-EI)...146(-EI)	CA9-TX146
			CA9-190(-EI)...205(-EI)	CA9-TX205
			CA9-265(-EI)...370(-EI)	CA9-TX370
			CA9-400-EI...460-EI	CA9-TX460
		CA9-580-EI...750-EI	CA9-TX750	

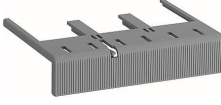
Terminal Shrouds

Accessory	Description	For use with...	Catalog Number
	For contactors with Compression Lugs <ul style="list-style-type: none"> Package contains 2 shrouds, one for Line and one for Load side Not applicable when using CA9-PW-power wiring kits. 	CA9-116(-EI)...146(-EI)	CA9-TS146L
		CA9-190(-EI)...205(-EI)	CA9-TS205C
		CA9-265(-EI)...370(-EI)	CA9-TS370C
		CA9-400-EI...460-EI	CA9-TS460C
		CA9-580-EI...750-EI, 1260-EI	CA9-TS750C
	For contactors with Terminal Lugs <ul style="list-style-type: none"> Package contains 2 shrouds, one for Line and one for Load side Not applicable when using CA9-PW-power wiring kits. 	CA9-190(-EI)...205(-EI)	CA9-TS205L
		CA9-265(-EI)...370(-EI)	CA9-TS370L ②
		CA9-400-EI...460-EI	CA9-TS460L
		CA9-580-EI...750-EI	CA9-TS750L
	For IP20 protection between contactor and overload relay on a non-reversing starter	CAT9-116(-EI)...146(-EI)	CA9-TC146
		CAT9-190(-EI)...205(-EI)	CA9-TC205
	For IP20 protection between contactor and overload relay on a reversing starter	CAUT9-116(-EI)...146(-EI)	CA9-TCR146
		CAUT9-190(-EI)...205(-EI)	CA9-TCR205

① Contactors CA9-1260...2650 are intended for busbar connection only. Lugs should be sourced separately and are not available from Sprecher + Schuh
 ② Not applicable with CA9-TL370B dual lugs.

See page A109 for terminal wire ranges.

Power Wiring Connection Kits

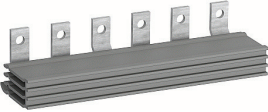
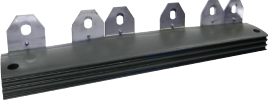
Connection Kits	Application	For use with...		Catalog Number
 <p>CA9-PW146</p>  <p>CA9-PWD460</p>	Reversing Power Wiring Kits	CA9-116(-EI)...146(-EI)		CA9-PW146
		CA9-190(-EI)...205(-EI)		CA9-PW205 ①
		CA9-265(-EI)...370(-EI)		CA9-PW370 ①
		CA9-400-EI...460-EI		CA9-PW460 ②
		CA9-580-EI...750-EI		CA9-PW750 ②
	Wye-Delta Power Wiring Kits	Delta Contactor	Wye Contactor	
		CA9-116(-EI)...146(-EI)	CA9-116(-EI)...146(-EI)	CA9-PWD146
		CA9-190(-EI)...205(-EI)	CA9-116(-EI)...146(-EI)	CA9-PWD190
		CA9-190(-EI)...205(-EI)	CA9-190(-EI)...205(-EI)	CA9-PWD205
		CA9-265(-EI)...370(-EI)	CA9-190(-EI)...205(-EI)	CA9-PWD265
		CA9-265(-EI)...370(-EI)	CA9-265(-EI)...370(-EI)	CA9-PWD370
		CA9-400-EI...460-EI	CA9-400-EI...460-EI	CA9-PWD460
		CA9-580-EI...750-EI	CA9-400-EI...460-EI	CA9-PWD580
	CA9-580-EI...750-EI	CA9-580-EI...750-EI	CA9-PWD750	
	Shorting Bar	CA9-116(-EI)...146(-EI)		CA9-PWY146
CA9-190(-EI)...205(-EI)		CA9-PWY205		
CA9-265(-EI)...370(-EI)		CA9-PWY370		
CA9-400-EI...460-EI		CA9-PWY460		
CA9-580-EI...750-EI		CA9-PWY750		

Mounting Plates (For CA9-116...750 Contactors)

Application	Description	For use with...	Catalog Number
	Non-Reversing Starters	CA9-116(-EI)...146(-EI)	CA9-MS146
		CA9-190(-EI)...205(-EI)	CA9-MS205
	Reversing Contactors	CA9-116(-EI)...146(-EI)	CA9-MR146
		CA9-190(-EI)...205(-EI)	CA9-MR205
		CA9-265(-EI)...370(-EI)	CA9-MR370
		CA9-400-EI...460-EI	CA9-MR460
		CA9-580-EI...750-EI	CA9-MR750
	Reversing Starters	CA9-116(-EI)...146(-EI)	CA9-MRS146
		CA9-190(-EI)...205(-EI)	CA9-MRS205

- ① Power wiring kit includes one set of terminal extensions CA9-TX_ . If terminal lugs CA9-TL_ are to be used on line and load side of reversing contactor, a second set of CA9-TX_ terminal extensions is required.
- ② If terminal lugs CA9-TL_ are to be used on the line and load side of reversing contactor, two sets of terminal extensions CA9-TX_ are also required (none included).

Renewal Coils - AC/DC, Electronic Coil

Electronic Coil (typical)	For use with...	Voltage	Coil Code	Catalog Number
 <p>Replacement Coil without EI Interface includes coil and cover</p>	CA9-116	24-60V AC/DC	24W	CA9-TG913
		48-130V AC/DC	48W	CA9-TG914
		100-250V AC/DC	120W	CA9-TG915
		250-500V AC/DC	480W	CA9-TG916
	CA9-116-EI	100-250V AC/DC w/ PLC Interface	120W	CA9-TGE913
		250-500V AC/DC w/ PLC Interface	480W	CA9-TGE914
	CA9-146	24-60V AC/DC	24W	CA9-TG901
		48-130V AC/DC	48W	CA9-TG902
		100-250V AC/DC	120W	CA9-TG903
		250-500V AC/DC	480W	CA9-TG904
	CA9-146-EI	100-250V AC/DC w/ PLC Interface	120W	CA9-TGE903
		250-500V AC/DC w/ PLC Interface	480W	CA9-TGE904
	CA9-190 CA9-205	24-60V AC/DC	24W	CA9-TG905
		48-130V AC/DC	48W	CA9-TG906
		100-250V AC/DC	120W	CA9-TG907
		250-500V AC/DC	480W	CA9-TG908
CA9-190-EI	100-250V AC/DC w/ PLC Interface	120W	CA9-TGE915	
	250-500V AC/DC w/ PLC Interface	480W	CA9-TGE916	
CA9-205-EI	100-250V AC/DC w/ PLC Interface	120W	CA9-TGE907	
	250-500V AC/DC w/ PLC Interface	480W	CA9-TGE908	
CA9-265...370	24-60V AC/DC	24W	CA9-TG909	
	48-130V AC/DC	48W	CA9-TG910	
	100-250V AC/DC	120W	CA9-TG911	
	250-500V AC/DC	480W	CA9-TG912	
CA9-265-EI	100-250V AC/DC w/ PLC Interface	120W	CA9-TGE917	
	250-500V AC/DC w/ PLC Interface	480W	CA9-TGE918	
CA9-305-EI	100-250V AC/DC w/ PLC Interface	120W	CA9-TGE919	
	250-500V AC/DC w/ PLC Interface	480W	CA9-TGE920	
CA9-370-EI	100-250V AC/DC w/ PLC Interface	120W	CA9-TGE911	
	250-500V AC/DC w/ PLC Interface	480W	CA9-TGE912	
CA9-400-EI, CA9-460-EI	24-60V DC	24W	CA9-THE901	
	48-130V AC/DC	48W	CA9-THE902	
	100-250V AC/DC	120W	CA9-THE903	
	250-500V AC/DC	480W	CA9-THE904	
CA9-580...750-EI, CA9-1260-EI	24-60V DC	24W	CA9-TJE901	
	48-130V AC/DC	48W	CA9-TJE902	
	100-250V AC/DC	120W	CA9-TJE903	
	250-500V AC/DC	480W	CA9-TJE904	
CA9-860-EI...1060-EI, CA9-2050-EI	100-250V AC/DC	120W	CA9-TKE903 ❶	
			CA9-TKE904 ❷	
CA9-2650-EI	100-250V AC/DC	120W	CA9-TLE903 ❶	
			CA9-TLE904 ❷	

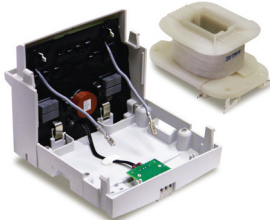

❶ One set of two (2) coils.
❷ Printed circuit board.

Renewal Contact Kits and Arc Chutes

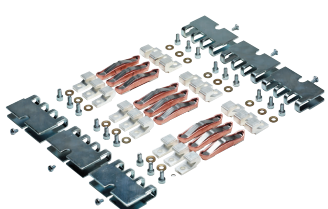
	Description	For use with...	Catalog Number
	Contact Kits	CA9-116(-EI)	CA9-A116
		CA9-146(-EI)	CA9-A146
		CA9-190(-EI)	CA9-A190
		CA9-205(-EI)	CA9-A205
		CA9-265(-EI)	CA9-A265
		CA9-305(-EI)	CA9-A305
		CA9-370(-EI)	CA9-A370
		CA9-400-EI	CA9-A400
		CA9-460-EI	CA9-A460
		CA9-580-EI	CA9-A580
		CA9-750-EI	CA9-A750
		CA9-860-EI	CA9-A860
		CA9-1060-EI	CA9-A1060
		CA9-1260-EI	CA9-A1260
		CA9-2050-EI	CA9-A2050
	CA9-2650-EI	CA9-A2650 ❶	
	Arc Chutes	CA9-400-EI...460-EI	CA9-C460
		CA9-580-EI...750-EI, CA9-1260-EI	CA9-C750
		CA9-860-EI...1060-EI, CA9-2050-EI	CA9-C1060
		CA9-2650-EI	CA9-C2650

Replacement Terminal Hardware

	Description	For use with...	Catalog Number
	Standard Screws and Washers	CA9-116...146(-EI)...-L	CA9-HS146 ❷
		CA9-116...146(-EI)	CA9-HF146
		CA9-190...205(-EI)	CA9-HF205
		CA9-265...370(-EI)	CA9-HF370
		CA9-400...460-EI	CA9-HF460
		CA9-580, 750, 1060-EI	CA9-HF750
		CA9-2050-EI	CA9-HF2050
		CA9-2650-EI	CA9-HF2650

❶ Movable contacts only.
 ❷ Mounting hardware only.

CA9 Contactors

Contactors Cross Reference, Series CA1 & CA6 to Series CA9 (Open Type Only) ①

I _e [A]		Ratings for Switching AC Motors (AC2 / AC3 / AC4)										Series CA1 Obsolete Catalog Number	Series CA6 Obsolete Catalog Number	Series CA9 Equivalent Catalog Number
		kW (50 Hz)				UL/CSA HP (60 Hz)								
		AC-3	AC-1	230V	400V / 415V	500V	690V	1 Ø		3 Ø				
115V	230V							200V	230V	460V	575V			
115	250	37	64/66	80	111	10	25	40	40	75	100		CA6-115	
116	160	30	55	75	55			30	40	75	100			CA9-116
						10	25	40	40	75	100	CA1-60		
140	250	45	78/82	80	111	15	30	40	50	100	125		CA6-140	
146	225	45	75	90	90			40	50	100	125			CA9-146
						15	30	50	50	100	125	CA1-100		
180	250	57	101/105	98	135	~	40	50	60	150	150		CA6-180	
190	275	55	90	90	132			50	60	125	150			CA9-190
						~	~	60	60	150	150	CA1-150		
205	350	55	110	110	160			60	75	150	200			CA9-205
210	350	67	118/122	147	205	~	50	60	75	150	200		CA6-210	
						~	~	75	100	200	250	CA1-250		
250	350	80	140/145	177	250	~	~	75	100	200	250		CA6-250	
265	400	75	132	160	200			75	100	200	250			CA9-265
300	450	97	170/176	213	293	~	~	100	125	250	300		CA6-300	
305	500	90	160	200	250			100	125	250	300			CA9-305
						~	~	150	150	350	400	CA1-480		
400	600	110	200/220	250	315			125	150	350	400			CA9-400
420	500	135	238/250	298	424	~	~	150	175	350	400		CA6-420	
460	700	132	250	315	355			150	200	400	500			CA9-460
580	800	160	315/355	400	500			200	250	500	600			CA9-580
630	800	200	355	450	500	~	~	200	250	500	600		CA6-630	
750	1050	220	400/425	520	600			250	300	600	700			CA9-750
860	1000	250	500	560	~	~	~	250	300	600	700		CA6-860	
860	1350	257	475/500	560	800			~	400	800	1000			CA9-860



CA1-10
Contactor



CA6-140-EI contactor

① Available auxiliary contacts may vary. See selection pages for more information.

General Data

CA9-116...2650		
Rated Isolation Voltage U_i		
IEC	[V]	1000V
UL; CSA	[V]	600V
Rated Voltage U_{mp}	(kV)	8
Rated Voltage U_e - Main Contacts		
AC 50/60Hz	[V]	115,200,230,240,400,415,460,500,575,690,1000
DC	[V]	24, 48, 110, 220, 440
Operating Frequency for AC Loads	[Hz]	50/60Hz
Electromagnetic compatibility	IEC 60947-1 - Environment A	
Insulation Class of the Coil	Class F per IEC 60947-4-1	
Rated Coil Frequency	AC 50/60 Hz, DC	
Ambient Temperature		
Storage	[°C]	-40...+70
Operation at rated voltage	[°C]	-40...+70
Max. Altitude of Installation Site	[m]	3000
Climatic Withstand		
CA9-116...370:	IEC 60068-2-30 Test Db & IEC 60068-2-2 test Bd & IEC 60068-2-1 test Ab (report 1314369)	
CA9-400...2650:	IEC 60068-2-2 test Ba & Bb & IEC 60068-2-1 test Aa & Ab, IEC 60068-2-30	
Resistance to Shock	IEC 60068-2-27	
Resistance to Vibration	IEC 60068-2-6	
Protection Class		
Contactor main contacts	IP00	
Contactor coil terminals	P2X (in connected state)	
Auxiliary contacts	P2X (in connected state)	

Standards	IEC/EN 60947-1, Low-voltage switch gear and control gear; IEC/EN 60947-4-1, Low-voltage switch gear and control gear, Contactors and motor starters; IEC/EN 60947-5-1, Low-voltage switch gear and control gear, Control circuit devices and switching elements; UL 60947-4-1, Industrial Control Equipment (USA); CSA C22.2 No. 14, Industrial Control Equipment (Canada) Mechanically Linked Contacts: IEC 60947-5-1, Annex L
	Mirror Contacts: IEC 60947-4-1, Annex F CA9-116...750 with all CA9-S* side mounted NC auxiliary contacts
Approvals	cULus, File No. E41850/E196120 (contactors, reversing contactors) CCC, EAC, RINA, ABS, RCM
Certifications	CE, SUVA

Electrical Data, Main Circuits

Coil Type:	Electronic	CA9-116	CA9-146	CA9-190	CA9-205	CA9-265	CA9-305	CA9-370	CA9-400	CA9-460	CA9-580	CA9-750	CA9-860	CA9-1060	CA9-1260	CA9-2050	CA9-2650
AC-1 Active Power Load (50/60Hz)																	
Ambient temperature 40°C	690V [A]	160	225	275	350	400	500	600	600	700	800	1050	1350	1650	1260	2050	2650
	1000V [A]	160	225	250	275	350	375	400	600	700	800	1000	1350	1650	1260	2050	2650
	230V [kW]	64	90	110	136	159	199	239	239	279	319	418	538	657	502	817	1056
	240V [kW]	67	94	114	145	166	208	249	249	291	333	436	561	686	524	852	1102
	400V [kW]	111	156	191	242	277	346	416	416	485	554	727	935	1143	873	1420	1836
	415V [kW]	115	162	198	252	288	359	431	431	503	575	755	970	1186	906	1474	1905
	500V [kW]	139	195	238	303	346	433	520	520	606	693	909	1169	1429	1091	1775	2295
	690V [kW]	191	269	329	418	478	598	717	717	837	956	1255	1613	1972	1506	2450	3167
	1000V [kW]	277	390	433	476	606	650	693	1039	1212	1386	1732	2338	2858	2182	3551	4590
Ambient temperature 60°C	690V [A]	145	200	250	300	350	400	500	500	600	700	875	1150	1450	1040	1750	2350
	1000V [A]	145	200	225	250	300	325	350	500	600	700	875	1150	1450	1040	1750	2350
	230V [kW]	58	80	100	120	139	159	199	199	239	279	349	458	578	414	697	936
	240V [kW]	60	83	104	125	145	166	208	208	249	291	364	478	603	432	727	977
	400V [kW]	100	139	173	208	242	277	346	346	416	485	606	797	1005	721	1212	1628
	415V [kW]	104	144	180	216	252	288	359	359	431	503	629	827	1042	748	1258	1689
	500V [kW]	126	173	217	260	303	346	433	433	520	606	758	996	1259	901	1516	2035
	690V [kW]	173	239	299	359	418	478	598	598	717	837	1046	1374	1733	1243	2091	2809
	1000V [kW]	251	346	390	433	520	563	606	866	1039	1212	1516	1992	2511	1801	3031	4070
Ambient temperature 70°C	690V [A]	130	175	200	240	290	325	400	400	480	580	720	1000	1270	875	1500	2120
	1000V [A]	130	175	185	200	240	260	290	400	480	580	720	1000	1270	875	1500	2120
	230V [kW]	52	70	80	96	116	129	159	159	191	231	287	398	506	349	598	845
	240V [kW]	54	73	83	100	121	135	166	166	200	241	299	416	528	364	624	881
	400V [kW]	90	121	139	166	201	225	277	277	333	402	499	693	880	606	1039	1469
	415V [kW]	93	126	144	173	208	234	288	288	345	417	518	719	913	629	1078	1524
	500V [kW]	113	152	173	208	251	281	346	346	416	502	624	866	1100	758	1299	1836
	690V [kW]	155	209	239	287	347	388	478	478	574	693	860	1195	1518	1046	1793	2534
	1000V [kW]	225	303	320	346	416	450	502	693	831	1005	1247	1732	2200	1516	2598	3672
With conductor sizes	[mm ²]	70	95	150	240 ^①	240	300 ^②	2x185 ^②	2x185	2x240	2x240	800 ^③	1000 ^④	1500 ^④	1000 ^③	2000 ^④	3000 ^④

① For currents above 275A, use terminal extensions.

② For currents above 450A, use terminal extensions.

③ Maximum connection bar width 50mm.

④ Maximum connection bar width 100mm.

Electrical Data, Main Circuits

Coil Type:	Electronic	CA9-116	CA9-146	CA9-190	CA9-205	CA9-265	CA9-305	CA9-370	CA9-400	CA9-460	CA9-580	CA9-750	CA9-860	CA9-1060	CA9-1260	CA9-2050	CA9-2650		
Switching of 3-phase Motors; (50Hz)																			
Ambient temperature 60°C, AC-2, AC-3	220-240V	[A]	116	146	190	205	265	305	370	400	460	580	750	860	1060	~	~	~	
	380-400V	[A]	116	146	190	205	265	305	370	400	460	580	750	860	1060	~	~	~	
	415V	[A]	116	146	190	205	265	305	370	400	460	580	750	860	1060	~	~	~	
	440V	[A]	116	146	190	205	265	305	370	400	460	580	750	860	1060	~	~	~	
	500V	[A]	110	130	156	185	250	290	350	400	460	580	750	800	970	~	~	~	
	690V	[A]	66	93	135	165	250	290	315	350	400	500	650	800	970	~	~	~	
	1000V	[A]	46	60	85	100	113	131	141	155	200	250	300	375	400	~	~	~	
	220-240V	[kW]	37	45	55	55	75	90	110	110	132	160	220	250	315	~	~	~	
	380-400V	[kW]	55	75	90	110	132	160	200	200	250	315	400	475	560	~	~	~	
	415V	[kW]	55	75	90	110	132	160	200	220	250	355	425	500	630	~	~	~	
	440V	[kW]	75	90	110	132	160	160	200	220	250	355	450	560	710	~	~	~	
	500V	[kW]	75	90	110	132	160	200	250	250	315	400	530	630	710	~	~	~	
	690V	[kW]	63	90	132	160	200	250	315	315	355	500	600	800	1000	~	~	~	
	1000V	[kW]	55	75	110	132	160	185	200	220	280	355	400	555	600	~	~	~	
	Load Carrying Capacity per cULus																		
	General Purpose Current (enclosed)	[A]	160	200	250	300	350	400	520	550	650	750	900	1350	1650	1210	2100	2700	
		200V	[A]	92	120	150	177	221	285	359	359	414	552	692	954	1030	~	~	~
		230V	[A]	104	130	154	192	248	312	360	360	480	604	722	954	1030	~	~	~
		460V	[A]	96	124	156	180	240	302	361	414	477	590	722	954	1030	~	~	~
Rated Power (enclosed), 3-Phase	575V	[A]	99	125	144	192	242	289	336	382	472	578	672	944	1050	~	~	~	
3-Phase	200V	[HP]	30	40	50	60	75	100	125	125	150	200	250	~	~	~	~	~	
	230V	[HP]	40	50	60	75	100	125	150	150	200	250	300	400	450	~	~	~	
	460V	[HP]	75	100	125	150	200	250	300	350	400	500	600	800	900	~	~	~	
	575V	[HP]	100	125	150	200	250	300	350	400	500	600	700	1000	1150	~	~	~	
with 3 poles in series	260V DC	[A]	160	200	~	~	~	~	~	~	~	~	~	~	~	~	~		
	300V DC	[A]	~	~	230	250	~	~	~	~	~	~	~	~	~	~	~		
	340V DC	[A]	~	~	~	~	350	400	520	~	~	~	~	~	~	~	~		
	600V DC	[A]	~	~	~	~	~	~	~	500	650	750	900	1050	1350	1210	1900		

Electrical Data, Main Circuits

Coil Type:	Electronic	CA9-116	CA9-146	CA9-190	CA9-205	CA9-265	CA9-305	CA9-370	CA9-400	CA9-460	CA9-580	CA9-750	CA9-860	CA9-1060	CA9-1260	CA9-2050	CA9-2650
Switching of 3-phase Motors, (50Hz)																	
Ambient temperature	230V	[A]	84	103	128	156	195	230	280	307	377	~	~	~	~	~	~
60°C, AC-4	240V	[A]	84	103	125	156	195	230	280	307	377	~	~	~	~	~	~
	400V	[A]	84	103	128	156	195	230	280	307	377	~	~	~	~	~	~
	415V	[A]	84	103	128	156	195	230	280	307	377	~	~	~	~	~	~
	500V	[A]	84	103	128	156	195	230	280	307	377	~	~	~	~	~	~
	690V	[A]	66	80	93	104	153	162	188	313	350	~	~	~	~	~	~
	1000V	[A]	40	48	72	85	90	95	100	141	155	~	~	~	~	~	~
	230V	[kW]	25	32	40	50	55	75	90	90	110	~	~	~	~	~	~
	240V	[kW]	25	32	40	50	63	75	90	100	125	~	~	~	~	~	~
	400V	[kW]	45	55	63	80	110	132	160	160	200	~	~	~	~	~	~
	415V	[kW]	45	55	63	90	110	132	160	160	220	~	~	~	~	~	~
	500V	[kW]	55	63	90	110	132	160	200	220	250	~	~	~	~	~	~
	690V	[kW]	63	75	90	100	150	160	185	315	335	~	~	~	~	~	~
	1000V	[kW]	55	63	100	110	125	132	130	200	220	~	~	~	~	~	~
AC-4 at approximately 200,000 operations																	
	230V	[A]	38	38	49	55	73	89	100	118	135	~	~	~	~	~	~
	240V	[A]	38	38	49	55	73	89	100	118	135	~	~	~	~	~	~
	400/415V	[A]	38	38	49	55	73	89	100	118	135	~	~	~	~	~	~
	500V	[A]	33	33	37	44	53	59	68	78	89	~	~	~	~	~	~
	690V	[A]	33	33	37	44	53	59	68	78	89	~	~	~	~	~	~
	1000V	[A]	~	~	~	~	~	~	~	~	~	~	~	~	~	~	~
	230V	[kW]	11	11	13	15	22	25	30	37	40	~	~	~	~	~	~
	240V	[kW]	11	11	15	15	22	25	32	37	45	~	~	~	~	~	~
	400V	[kW]	20	20	25	30	40	50	55	63	75	~	~	~	~	~	~
	415V	[kW]	20	20	25	30	40	50	55	63	75	~	~	~	~	~	~
	500V	[kW]	22	22	25	30	37	40	45	55	63	~	~	~	~	~	~
	690V	[kW]	30	30	32	40	50	55	63	75	80	~	~	~	~	~	~
	1000V	[kW]	~	~	~	~	~	~	~	~	~	~	~	~	~	~	~
Max. switching frequency	[ops/hr]	150	150	150	150	150	150	150	150	60	60	~	~	~	~	~	~
Wye-Delta (60Hz)																	
	200V	[HP]	50	60	75	100	125	150	200	200	250	~	~	~	~	~	~
	230V	[HP]	60	75	100	125	150	200	250	250	350	450	500	~	~	~	~
	460V	[HP]	125	150	200	250	350	450	500	500	600	800	~	~	~	~	~
	575V	[HP]	150	200	250	300	450	500	600	600	700	1000	~	~	~	~	~

Electrical Data, Main Circuits

Coil Type:	Electronic	CA9-116	CA9-146	CA9-190	CA9-205	CA9-265	CA9-305	CA9-370	CA9-400	CA9-460	CA9-580	CA9-750	CA9-860	CA9-1060	CA9-1260	CA9-2050	CA9-2650	
cULus Elevator Duty																		
	200V [A]	54	54	77	99	125	149	156	~	~	~	~	~	~	~	~	~	
	230V [A]	54	54	77	99	125	149	156	~	~	~	~	~	~	~	~	~	
	460V [A]	54	54	77	99	125	149	156	~	~	~	~	~	~	~	~	~	
	575V [A]	54	54	77	99	125	149	156	~	~	~	~	~	~	~	~	~	
	200V [HP]	15	15	20	30	40	40	50	~	~	~	~	~	~	~	~	~	
	230V [HP]	20	20	25	30	40	50	60	~	~	~	~	~	~	~	~	~	
	460V [HP]	40	40	60	75	100	100	125	~	~	~	~	~	~	~	~	~	
	575V [HP]	50	50	75	100	125	150	150	~	~	~	~	~	~	~	~	~	
cULus HVAC Applications																		
Definite purpose rating (3-Phase)																		
	FLA [A]	116	160	200	250	300	350	520	~	~	~	~	~	~	~	~	~	
	230V [A]	700	960	1200	1500	1800	2100	3120	~	~	~	~	~	~	~	~	~	
	LRA 460V [A]	580	800	1000	1250	1500	1750	2600	~	~	~	~	~	~	~	~	~	
	575V [A]	470	640	800	1000	1200	1400	2080	~	~	~	~	~	~	~	~	~	
	AC resistance heating 600V [A]	160	200	250	300	400	450	520	~	~	~	~	~	~	~	~	~	
Star-Delta Starting (50Hz)																		
	≥230V [A]	200	252	329	355	458	528	640	692	796	1004	1299	1489	1835	~	~	~	
	≥240V [A]	200	252	329	355	458	528	640	692	796	1004	1299	1489	1835	~	~	~	
	400V [A]	200	252	329	355	458	528	640	692	796	1004	1299	1489	1835	~	~	~	
	415V [A]	200	252	329	355	458	528	640	692	796	1004	1299	1489	1835	~	~	~	
	500V [A]	190	225	233	285	433	502	545	692	796	1004	1299	1385	1680	~	~	~	
	690V [A]	112	161	233	285	433	502	545	692	796	1004	1299	1385	1680	~	~	~	
	1000V [A]	~	103	147	173	173	173	173	268	346	433	519	~	~	~	~	~	
	230V [kW]	55	75	90	110	132	160	200	200	250	315	400	500	560	~	~	~	
	240V [kW]	55	75	110	110	132	160	200	200	250	315	400	500	630	~	~	~	
	400V [kW]	110	132	160	200	250	250	355	400	400	560	710	800	1000	~	~	~	
	415V [kW]	110	132	160	200	250	315	355	400	400	560	800	900	1100	~	~	~	
	500V [kW]	132	160	160	200	315	355	355	500	500	713	800	1000	1300	~	~	~	
	690V [kW]	90	132	200	250	400	500	500	560	710	800	1100	1400	1700	~	~	~	
	1000V [kW]	~	132	200	250	250	250	250	355	500	630	710	~	~	~	~	~	

① Power rating at 50Hz. Preferred values according to IEC 60947-4-1.

Electrical Data, Main Circuits

Coil Type:	Electronic	CA9-116	CA9-146	CA9-190	CA9-205	CA9-265	CA9-305	CA9-370	CA9-400	CA9-460	CA9-580	CA9-750	CA9-860	CA9-1060	CA9-1260	CA9-2050	CA9-2650
------------	------------	---------	---------	---------	---------	---------	---------	---------	---------	---------	---------	---------	---------	----------	----------	----------	----------

Switching of Power Transformers, AC-6a (50Hz)

		Inrush Current Rated transformer current = n															
n = 30	≥230V [A]	70	79	111	115	143	143	165	200	252	263	286	430	254	362	~	~
	≥240V [A]	70	79	111	115	143	143	165	200	252	263	286	430	254	362	~	~
	≥400V [A]	70	79	111	115	143	143	165	200	252	263	286	430	254	362	~	~
	≥415V [A]	70	79	111	115	143	143	165	200	252	263	286	430	254	362	~	~
	≥500V [A]	70	79	111	115	143	143	165	200	252	263	286	~	~	362	~	~
	≥690V [A]	70	79	111	115	143	143	165	200	252	263	286	~	~	362	~	~
	≥1000V [A]	~	~	~	~	~	~	~	~	~	~	~	~	~	~	~	~
Apparent Power	230V [kW]	28	31	44	46	57	57	66	80	100	105	114	171	209	144	~	~
	240V [kW]	29	33	46	48	59	59	69	83	105	109	119	179	218	150	~	~
	400V [kW]	48	55	77	80	99	99	114	139	175	182	198	298	363	251	~	~
	415V [kW]	50	56	79	82	102	102	117	142	179	187	203	305	372	257	~	~
	500V [kW]	61	68	96	100	124	124	143	173	218	228	248	~	~	314	~	~
	690V [kW]	84	94	133	137	171	171	197	239	301	314	342	~	~	433	~	~
	1000V [kW]	~	~	~	~	~	~	~	~	~	~	~	~	~	~	~	~
n = 20	≥690V [A]	105	119	167	173	215	215	248	300	378	395	429	~	~	543	~	~
n = 15	≥690V [A]	140	158	222	230	286	286	330	400	504	526	572	~	~	724	~	~

60 Hz Peak Inrush/peak rated transformer current

n = 30	≥660V [A]	70	79	111	115	143	143	165	200	252	263	286	430	524	362	~	~
	200V [kVA]	24	27	38	40	50	50	57	69	87	91	99	149	182	125	~	~
	208V [kVA]	25	28	40	41	52	52	59	72	91	95	103	155	189	130	~	~
	240V [kVA]	29	33	46	48	59	59	69	83	105	109	119	179	218	150	~	~
	480V [kVA]	58	66	92	96	119	119	137	166	210	219	238	357	436	301	~	~
	600V [kVA]	73	82	115	120	149	149	171	208	262	273	297	447	545	376	~	~
	660V [kVA]	80	90	127	131	163	163	189	229	288	301	327	492	599	414	~	~
n = 20	≥660V [A]	105	119	167	173	215	215	248	300	378	395	429	645	786	543	~	~
Apparent Power	200V [kVA]	36	41	58	60	74	74	86	104	131	137	149	223	272	188	~	~
	208V [kVA]	38	43	60	62	77	77	89	108	136	142	155	232	283	196	~	~
	240V [kVA]	44	49	69	72	89	89	103	125	157	164	178	268	327	226	~	~
	480V [kVA]	87	99	139	144	179	179	206	249	314	328	357	536	653	451	~	~
	600V [kVA]	109	124	174	180	223	223	258	312	393	410	446	670	817	564	~	~
	660V [kVA]	120	136	191	198	246	246	284	343	432	452	490	737	899	621	~	~
n = 15	≥660V [A]	140	158	222	230	286	286	330	400	504	526	572	860	1048	724	~	~
Apparent Power	200V [kVA]	48	55	77	80	99	99	114	139	175	182	198	298	363	251	~	~
	208V [kVA]	50	57	80	83	103	103	119	144	182	190	206	310	378	261	~	~
	240V [kVA]	58	66	92	96	119	119	137	166	210	219	238	357	436	301	~	~
	480V [kVA]	116	131	185	191	238	238	274	333	419	437	476	715	871	602	~	~
	600V [kVA]	145	164	231	239	297	297	343	416	524	547	594	894	1089	752	~	~
	660V [kVA]	160	181	254	263	327	327	377	457	576	601	654	983	1198	828	~	~

Electrical Data, Main Circuits

Coil Type:	Electronic	CA9-116	CA9-146	CA9-190	CA9-205	CA9-265	CA9-305	CA9-370	CA9-400	CA9-460	CA9-580	CA9-750	CA9-860	CA9-1060	CA9-1260	CA9-2050	CA9-2650
Switching of 3-Phase Capacitors, AC-6b (50Hz)																	
Single capacitor 40°C	230V [kVar]	40	50	60	75	85	100	110	120	140	170	220	250	300	~	~	~
	240V [kVar]	40	50	60	75	85	100	110	120	140	170	220	250	300	~	~	~
	400V [kVar]	75	90	110	130	145	165	200	210	240	285	400	450	500	~	~	~
	415V [kVar]	75	90	110	130	145	165	200	210	240	285	400	450	500	~	~	~
	500V [kVar]	83	110	140	160	180	210	240	260	325	350	490	550	600	~	~	~
	690V [kVar]	80	110	135	170	200	240	280	300	325	440	600	650	800	~	~	~
	1000V [kVar]	~	100	140	150	155	160	170	250	300	350	450	~	~	~	~	~
Single capacitor 55°C	230V [kVar]	40	50	60	75	85	100	110	120	140	170	220	250	300	~	~	~
	240V [kVar]	40	50	60	75	85	100	110	120	140	170	220	250	300	~	~	~
	400V [kVar]	75	90	110	130	145	165	200	210	240	285	400	450	500	~	~	~
	415V [kVar]	75	90	110	130	145	165	200	210	240	285	400	450	500	~	~	~
	500V [kVar]	83	110	140	160	180	210	240	260	325	350	490	550	600	~	~	~
	690V [kVar]	80	110	135	170	200	240	280	300	325	440	600	650	800	~	~	~
	1000V [kVar]	~	100	140	150	155	160	170	250	300	350	450	~	~	~	~	~
Single capacitor 70°C	230V [kVar]	35	42	45	57	70	85	100	105	120	160	190	230	280	~	~	~
	240V [kVar]	35	42	45	57	70	85	100	105	120	160	190	230	280	~	~	~
	400V [kVar]	65	74	83	105	135	155	180	195	225	275	370	430	480	~	~	~
	415V [kVar]	65	74	83	105	135	155	180	195	225	275	370	430	480	~	~	~
	500V [kVar]	78	96	102	130	165	196	220	241	300	340	435	530	570	~	~	~
	690V [kVar]	75	110	135	160	200	240	260	300	325	440	600	630	750	~	~	~
	1000V [kVar]	~	95	120	130	140	150	160	220	270	300	400	~	~	~	~	~
60Hz Single Capacitor - 40°C	200V [kVar]	33	41	50	67	83	100	125	114	137	171	205	~	346	~	~	~
	230V [kVar]	38	48	57	77	95	115	144	131	157	196	236	~	398	~	~	~
	460V [kVar]	75	100	125	150	200	250	300	274	329	411	494	~	832	~	~	~
	600V [kVar]	100	125	150	200	250	300	350	343	410	514	618	~	1040	~	~	~
Switching of Lamps																	
Gas discharge lamps AC-5a (Open)	[A]	116	146	190	205	265	305	370	400	460	580	750	877	1072	812	1332	1722
UL Ballast Ratings	[A]	160	200	250	300	400	450	520	~	~	~	~	~	~	~	~	~
Filament AC-5b	230/240V [A]	116	146	190	205	265	305	370	400	460	580	750	877	1072	812	1332	1722

Electrical Data, Main Circuits

Coil Type:	Electronic	CA9-116	CA9-146	CA9-190	CA9-205	CA9-265	CA9-305	CA9-370	CA9-400	CA9-460	CA9-580	CA9-750	CA9-860	CA9-1060	CA9-1260	CA9-2050	CA9-2650
------------	------------	---------	---------	---------	---------	---------	---------	---------	---------	---------	---------	---------	---------	----------	----------	----------	----------

Switching of DC Loads

Non-inductive or slightly inductive loads or resistance furnaces DC-1 at 60°C

1-Pole	≤72V	[A]	160	200	250	350	400	500	520	600	700	800	1050	1350	1650	1250	2050	~
	90V	[A]	160	200	250	350	400	500	520	~	~	~	~	~	~	~	~	~
	100V	[A]	~	~	250	350	400	500	520	~	~	~	~	~	~	~	~	~
	110V	[A]	~	~	~	~	400	500	520	600	700	800	1050	1350	1650	1250	2050	~
2 Poles in series	≤72V	[A]	160	200	250	350	400	500	520	600	700	800	1050	1350	1650	1250	2050	~
	110V	[A]	160	200	250	350	400	500	520	600	700	800	1050	1350	1650	1250	2050	~
	175V	[A]	160	200	250	350	400	500	520	600	700	800	1050	~	~	~	~	~
	200V	[A]	~	~	250	350	400	500	520	600	700	800	1050	~	~	~	~	~
	220V	[A]	~	~	~	~	400	500	520	600	700	800	1050	~	~	~	~	~
3-Poles in series	≤72V	[A]	160	200	250	350	400	500	520	600	700	800	1050	1350	1650	1250	2050	~
	110V	[A]	160	200	250	350	400	500	520	600	700	800	1050	1350	1650	1250	2050	~
	175V	[A]	160	200	250	350	400	500	520	600	700	800	1050	1350	1650	1250	2050	~
	220V	[A]	160	200	250	350	400	500	520	600	700	800	1050	1350	1650	1250	2050	~
	260V	[A]	160	200	250	350	400	500	520	600	700	800	1050	1350	1650	1250	2050	~
	300V	[A]	~	~	250	350	400	500	520	600	700	800	1050	1350	1650	1250	2050	~
	340V	[A]	~	~	~	~	400	500	520	600	700	800	1050	1350	1650	1250	2050	~
	600V	[A]	~	~	~	~	~	~	~	600	700	800	1050	1350	1650	1250	2050	~
850V	[A]	~	~	~	~	~	~	~	~	~	800	1050	1350	1650	1250	2050	~	

Shunt-wound motors

Starting, reverse current breaking, reversing, stepping DC-3, 60°C

3-Poles in series	24V	[A]	145	160	250	275	350	400	450	600	700	800	1050	~	~	~	~	~
	48/60V	[A]	145	160	250	275	350	400	450	600	700	800	1050	~	~	~	~	~
	110V	[A]	145	160	250	275	350	400	450	600	700	800	1050	~	~	~	~	~
	220V	[A]	145	160	250	275	350	400	450	600	700	800	1050	~	~	~	~	~
	440V	[A]	~	~	~	~	~	~	~	600	700	800	1050	~	~	~	~	~

Series-wound motors

Starting, reverse current breaking, reversing, stepping DC-5, 60°C

3-Poles in series	24V	[A]	145	160	250	275	350	400	450	600	700	800	1050	~	~	~	~	~
	48/60V	[A]	145	160	250	275	350	400	450	600	700	800	1050	~	~	~	~	~
	110V	[A]	145	160	250	275	350	400	450	600	700	800	1050	~	~	~	~	~
	220V	[A]	145	160	250	275	350	400	450	600	700	800	1050	~	~	~	~	~
	440V	[A]	~	~	~	~	~	~	~	600	700	800	1050	~	~	~	~	~

Short Time Withstand /_{cw} 60° C

1 s	[A]	1300	1460	1900	2050	2650	3050	3700	4600	4600	7000	7000	10000	12000	8000	12000	12000
10 s	[A]	928	1168	1520	1640	2120	2446	2960	4400	4400	6400	6400	8000	10000	7200	10000	10000
30 s	[A]	536	674	878	947	1224	1409	1709	3100	3100	4500	4500	6000	7500	5200	7500	7500
1 min	[A]	379	477	621	670	865	996	1208	2500	2500	3500	3500	4500	5500	4000	5500	5500
15 min	[A]	160	225	275	350	400	500	600	840	840	1300	1300	1600	2200	1500	2200	2800

Resistance and Power Dissipation

Main current circuit resistance	[mΩ]	0.469	0.454	0.198	0.204	0.200	0.200	0.200	0.200	0.083	0.086	0.050	0.045	0.044	0.029	0.050	0.030	0.028
Power dissipation per pole at I _e AC-1, 400V	[W]	12	23	15	25	32	50	72	30	42	32	50	80	80	80	125	200	
Power dissipation per pole at I _e AC-3, 400V	[W]	6	10	7	8	14	19	27	16	21	17	28	50	50	~	~	~	
Total power dissipation at: I _e AC3, 400V; AC/DC control 120-250V)	[W]	21	33	23.5	26.5	46.5	61.5	85.5	53	68	56	89	171	171	~	~	~	

Maximum Switching Frequency

AC-1	ops/hr	300	300	300	300	300	300	300	300	300	300	300	60	60	300	60	15
AC-3	ops/hr	300	300	300	300	300	300	300	300	300	300	300	60	60	~	~	~
AC-2, AC-4	ops/hr	150	150	150	150	150	150	150	60	60	60	60	60	60	~	~	~

Weight

AC/DC (Electronic)	kg	1.5	1.5	3	3	4.64	4.64	4.64	12	12	15	15	34	35	16	35	45
with bar connections	(lbs)	(3.3)	(3.3)	(6.6)	(6.6)	(10.2)	(10.2)	(10.2)	(26.4)	(26.4)	(33)	(33)	(74.8)	(77)	(35.2)	(77)	(99)
with built-in cable clamps	kg	1.75	1.75	~	~	~	~	~	~	~	~	~	~	~	~	~	~
	(lbs)	(3.85)	(3.85)														

Short Circuit Ratings

		CA9-116	CA9-146	CA9-190	CA9-205	CA9-265	CA9-305	CA9-370	CA9-400	CA9-460	CA9-580	CA9-750	CA9-860	CA9-1060	CA9-1260	CA9-2050	CA9-2650	
Short Circuit Coordination (Max. Fuse or Circuit Breaker Rating)																		
per IEC 60947-4-1																		
DIN Fuses -gG 100 kA Available Fault Current																		
Type "2" (400V)	[A]	250	250	315	315	400	500	630	630	630	800	800	1000	1250	~	~	~	
DIN Fuses -gG 80 kA Available Fault Current																		
Type "2" (690V)	[A]	160	200	315	315	400	425	500	500	630	800	800	1000	1600	~	~	~	
MCCB 70 kA Available Fault Current																		
Type "2" (400V)	[A]	160	160	320	320	400	630	630	630	630	800	1000	1600	1600	~	~	~	
Short Circuit Coordination (Max. Fuse or Circuit Breaker Rating)																		
per UL 60947 and CSA 22.2 No. 14 (contactor and fuses or circuit breaker only)																		
UL Class RK5 Fuses 10 kA Available Fault Current																		
Type 1 Combination (600V)	[A]	250	250	400	400	~	~	~	~	~	~	~	~	~	~	~	~	
UL Class L Fuses 18 kA Available Fault Current																		
Type 1 Combination (600V)	[A]	~	~	~	~	800	800	800	1000	~	~	~	~	~	~	~	~	
UL Class L Fuses 30 kA Available Fault Current																		
Type 1 Combination (600V)	[A]	~	~	~	~	~	~	~	~	1000	~	~	~	~	~	~	~	
UL Class L Fuses 85 kA Available Fault Current																		
Type 1 Combination (600V)	[A]	~	~	~	~	~	~	~	~	~	~	~	1600	1600	~	~	~	
UL Class J and CSA HRCI-J Fuses 100 kA Available Fault Current																		
Type 1 Combination (600V)	[A]	250	250	400	400	600	600	800	600	600	~	~	~	~	~	~	~	
Type 2 Combination (600V)	[A]	200	200	400	400	600	600	600	600	600	~	~	~	~	~	~	~	
UL Class L Fuses 100 kA Available Fault Current																		
Type 1 Combination (600V)	[A]	~	~	~	~	~	~	~	800	800	1200	1200	~	~	1600	~	~	
Type 2 Combination (600V)	[A]	~	~	~	~	~	~	~	~	~	1200	1200	~	~	~	~	~	
UL Inverse-Time Circuit 42 kA Available Fault Current																		
Type 1 Combination (480V)	[A]	~	~	~	~	~	~	~	~	~	1200	1200	2000	2000	~	~	~	
UL Inverse-Time Circuit 65 kA Available Fault Current																		
Type 1 Combination (480V)	[A]	250	250	400	400	800	800	800	800	800	800	800	~	~	~	~	~	
UL Inverse-Time Circuit 84 kA Available Fault Current																		
Type 1 Combination (480V)	[A]	~	~	~	~	~	~	~	800	800	~	~	~	~	~	~	~	
UL Inverse-Time Circuit 89 kA Available Fault Current																		
Type 1 Combination (480V)	[A]	~	~	~	~	~	~	~	~	~	800	800	~	~	~	~	~	
UL Inverse-Time Circuit 100 kA Available Fault Current																		
Type 1 Combination (480V)	[A]	250	250	400	400	800	800	800	~	~	~	~	~	~	~	~	~	
UL Inverse-Time Circuit 25 kA Available Fault Current																		
Type 2 Combination (600V)	[A]	250	250	~	~	~	~	~	~	~	~	~	~	~	~	~	~	
UL Inverse-Time Circuit 35 kA Available Fault Current																		
Type 2 Combination (600V)	[A]	~	~	400	400	800	800	800	600	800	800	800	~	~	~	~	~	
UL Inverse-Time Circuit 42 kA Available Fault Current																		
Type 1 Combination (600V)	[A]	~	~	~	~	800	800	800	600	800	800	800	~	~	~	~	~	
UL Inverse-Time Circuit 50 kA Available Fault Current																		
Type 1 Combination (600V)	[A]	250	250	~	~	~	~	~	~	~	~	~	~	~	~	~	~	
UL Inverse-Time Circuit 65 kA Available Fault Current																		
Type 1 Combination (600V)	[A]	~	~	400	400	400	400	400	~	~	~	~	~	~	~	~	~	

Coil Data

Coil type: Electronic			CA9-116...146	CA9-190...205	CA9-265...370	CA9-400...460	CA9-580...750	CA9-860...1060	CA9-1260	CA9-2050...2650
Operating Limits										
50/60 Hz	pick-up	[xUs]	0.85...1.1							
	dropout	[xUs]	0.55							
DC control	pick-up	[xUs]	0.80...1.1							
	dropout	[xUs]	0.55							
24...60V AC	pick-up	[VA]	225	165	475	~	~	~	~	~
	hold-in	[VA]	5.5	6	8.5	~	~	~	~	~
48...130V AC	pick-up	[VA]	170	175	340	1215	1100	~	1100	~
	hold-in	[VA]	4	4	17	12	12	~	12	~
100...250V AC	pick-up	[VA]	130	220	385	955	880	2450	880	2450
	hold-in	[VA]	6	7	17.5	12	12	48	12	48
250...500V AC	pick-up	[VA]	205	185	420	950	985	~	985	~
	hold-in	[VA]	16	16	21	12	12	~	12	~
24...60V DC	pick-up	[W]	210	205	400	900	785	~	785	~
	hold-in	[W]	2.5	2.5	3.5	5	5.5	~	5.5	~
48...130V DC	pick-up	[W]	130	130	360	1150	1020	~	120	~
	hold-in	[W]	2.5	2.5	2.5	5	5	~	5	~
100...250V DC	pick-up	[W]	135	190	410	895	880	2290	880	2290
	hold-in	[W]	3	2.5	4.5	5	5	20.5	5	20.5
250...500V DC	pick-up	[W]	205	190	600	885	910	~	910	~
	hold-in	[W]	4	4	4.7	7.5	7.5	~	7.5	~
Operating Times										
AC or DC	closing delay	[ms]	20...55	25...60	30...60	50...120	50...120	50...80	50...120	50...80
	opening delay	[ms]	40...70	45...80	45...80	33...70	33...70	35...55	33...70	35...55
With PLC Interface	closing delay	[ms]	20...31	25...45	25...45	40...60	40...90	40...65	40...90	40...65
	opening delay	[ms]	24...34	25...45	25...45	10...30	10...30	10...30	10...30	10...30

Mechanical Data

		CA9-116	CA9-146	CA9-190	CA9-205	CA9-265	CA9-305	CA9-370	CA9-400	CA9-460	CA9-580	CA9-750	CA9-860	CA9-1060	CA9-1260	CA9-2050	CA9-2650	
Main Terminals																		
Conductor Cross Sections - Main Contacts Terminal Type																		
	(1) conductor Clamp Type	[mm ²] 10...95 CA9-CL146	[mm ²] 6...150 CA9-TL205	[mm ²] 16...300 CA9-TL370	~	~	~	~	~	~	~	~	~	~	~	~	~	~
Recommended torque		[Nm]	8	34	42	~	~	~	~	~	~	~	~	~	~	~	~	~
	(2) conductors Clamp Type	[mm ²] 10...95 CA9-CL146	~	~	~	[mm ²] 16...500 CA9-TL370B	[mm ²] 70...500 CA9-TL580	[mm ²] 70...500 CA9-TL750	[mm ²] 120...500 CA9-TL860	[mm ²] 70...750 CA9-TL1060	~	~	~	~	~	~	~	~
Recommended torque		[Nm]	8	~	~	42	31	43	43	57	~	~	~	~	~	~	~	~
	(3) conductors Clamp Type	[mm ²] ~	~	~	~	~	~	[mm ²] 70...500 CA9-TL750	[mm ²] 120...500 CA9-TL860	[mm ²] 70...750 CA9-TL1060	[mm ²] 70...500 CA9-TL750	~	~	~	~	~	~	~
Recommended torque		[Nm]	~	~	~	~	~	43	43	57	43	~	~	~	~	~	~	~
	(4) conductors Clamp Type	[mm ²] ~	~	~	~	~	~	~	~	[mm ²] 120...500 CA9-TL860	[mm ²] 70...750 CA9-TL1060	~	~	~	~	~	~	~
Recommended torque		[Nm]	~	~	~	~	~	~	~	43	57	~	~	~	~	~	~	~
	(6) conductors Clamp Type	[mm ²] ~	~	~	~	~	~	~	~	~	~	[mm ²] 70...750 CA9-TL1060B	~	~	~	~	~	~
Recommended torque		[Nm]	~	~	~	~	~	~	~	~	~	57	~	~	~	~	~	~
	L max.	[mm]	22	24	32	47	50	100	50	100	~	~	~	~	~	~	~	~
	ø min.	[mm]	6	8	10	10	12	12	12	12	~	~	~	~	~	~	~	~
Recommended torque		[Nm]	9	18	28	35	45	45	45	45	~	~	~	~	~	~	~	~



Cross Section per cULus

	(1) conductor Clamp Type	[AWG] 6...3/0 CA9-CL146	[MCM] 6...300 CA9-TL205	[MCM] 4...400 CA9-TL370	~	~	~	~	~	~	~	~	~	~	~	~	~	~
Recommended torque		[lb-in]	80	300	375	~	~	~	~	~	~	~	~	~	~	~	~	~
	(2) conductors Clamp Type	[AWG] 6...3/0 CA9-CL146	~	~	~	[MCM] 4...500 CA9-TL370B	[MCM] 2/0...500 CA9-TL580	[MCM] 2/0...500 CA9-TL750	[MCM] 4/0...500 CA9-TL860	[MCM] 1/0...750 CA9-TL1060	[MCM] 2/0...500 CA9-TL750	~	~	~	~	~	~	~
Recommended torque		[lb-in]	80	~	~	375	275	375	375	500	375	~	~	~	~	~	~	~
	(3) conductors Clamp Type	[AWG] ~	~	~	~	~	~	[MCM] 2/0...500 CA9-TL750	[MCM] 4/0...500 CA9-TL860	[MCM] 1/0...750 CA9-TL1060	[MCM] 2/0...500 CA9-TL750	~	~	~	~	~	~	~
Recommended torque		[lb-in]	~	~	~	~	~	375	375	500	375	~	~	~	~	~	~	~
	(4) conductors Clamp Type	[AWG] ~	~	~	~	~	~	~	[MCM] 4/0...500 CA9-TL860	[MCM] 1/0...750 CA9-TL1060	~	~	~	~	~	~	~	~
Recommended torque		[lb-in]	~	~	~	~	~	~	375	500	~	~	~	~	~	~	~	~
	(6) conductors Clamp Type	[AWG] ~	~	~	~	~	~	~	~	[MCM] 1/0...750 CA9-TL1060B	~	~	~	~	~	~	~	~
Recommended torque		[lb-in]	~	~	~	~	~	~	~	500	~	~	~	~	~	~	~	~
	L max.	[in]	0.866	0.945	1.26	1.85	1.97	3.94	1.97	3.94	~	~	~	~	~	~	~	~
	ø min.	[in]	0.236	0.315	0.394	0.394	0.472	0.472	0.472	0.472	~	~	~	~	~	~	~	~
Recommended torque		[lb-in]	80	160	248	310	398	398	398	398	~	~	~	~	~	~	~	~

Conductor Cross Sections

Coil Terminals																		
Terminal Type																		
	(1) conductor	[mm ²]															0.75...2.5	
	(2) conductors	[mm ²]															0.75...2.5	
	(1) conductor	[mm ²]															1...4	
	(2) conductors	[mm ²]															1...4	
Recommended torque		[Nm]															1...1.2	
Cross section per cULus		[AWG]															18...14	
Recommended torque		[lb-in]															8.9...10.6	

Electrical Data, Auxiliary Contacts

For Reversing and Non-Reversing			CA9-S1/2*	CA9-S3/4*	CA9-S*-B*	
Switching of AC Loads						
Rated Insulation voltage U_i			690V	690V	250V	
Rated Operational voltage U_e			690V	690V	125V	
Rated Impulse Withstand voltage U_{imp}			6kV	6kV	1.5kV	
AC-12 I_{th}	at 40°C	[A]	16	16	0.1	
	at 60°C	[A]	~	~	~	
AC-14 at rated voltage of	24V	[A]	~	~	0.1	
	42/48V	[A]	~	~	0.1	
	120V	[A]	~	~	0.1	
AC-15 at rated voltage of	24V	[A]	6	6	~	
	42/48V	[A]	6	6	~	
	120V	[A]	6	6	~	
	230V	[A]	4	4	~	
	240V	[A]	4	4	~	
	400V	[A]	3	3	~	
AC-15 at rated voltage of	415V	[A]	3	3	~	
	500V	[A]	2	2	~	
	690V	[A]	2	2	~	
	690V	[A]	2	2	~	
Switching of DC Loads						
DC-12 L/R < 1 ms resistive loads at	24V DC	[A]	~	~	0.1	
	48V DC	[A]	~	~	0.1	
	110V DC	[A]	~	~	0.1	
	220V DC	[A]	~	~	~	
	440V DC	[A]	~	~	~	
DC-12 L/R < 15 ms inductive loads with economy resistor in series at	24V DC	[A]	~	~	~	
	48V DC	[A]	~	~	~	
	110V DC	[A]	~	~	~	
	220V DC	[A]	~	~	~	
	440V DC	[A]	~	~	~	
DC-13 switching electromagnetics at	24V DC	[A]	3	6	~	
	48V DC	[A]	1.5	2.8	~	
	110V DC	[A]	0.55	0.55	~	
	220V DC	[A]	0.3	0.3	~	
	440V DC	[A]	~	~	~	
Fuse gG						
Short-circuit protection with no welding of contacts per IEC 60947-5-2		[A]	10	10	0.1	
		[A]	10	10	0.1	
Protective Separation per IEC 60947-1, Annex N						
Min. Switching capacity at 24V IEC 60947-5-4			[mA]	50	50	~
Min. Switching capacity at 3V IEC 60947-5-4			[kVA]	~	~	1
Load Carrying Capacity per cULus						
Rated voltage	AC	[V]	600	600	125	
Continuous rating	40°C	[A]	10	10	0.1	
Switching capacity	AC		A 600	A 600	~	
Rated voltage	DC	[V]	250	250	125	
Continuous rating	40°C	[A]	2.5	2.5	0.1	
Switching capacity	DC		P 600	Q 300	~	
	660V	[kVA]	160	181	254	

Life-Load Curves

3-Pole Contactors
Electrical Durability

Electrical durability for AC-1 utilization category - $U_e \leq 690V$ ①
Switching non-inductive or slightly inductive loads.
The breaking current I_c for AC-1 is equal to the rated operational current of the load.

A
CA9 Contactors

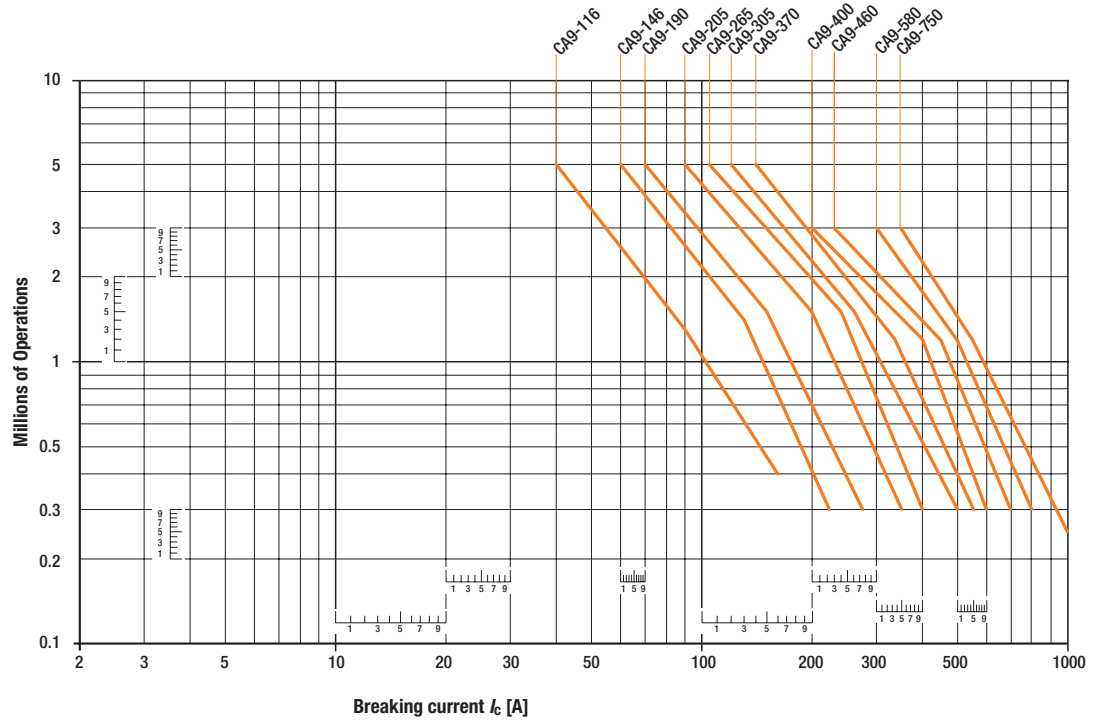

Instructions on
How to read
Life Curves
can be found on page A8

① CA9-860 and CA9-1060 electrical durability at the rated current is 50,000 operating cycles.

Life-Load Curves

3-Pole Contactors
Electrical Durability

Electrical durability for AC-3 utilization category - $U_e \leq 440V$ ❶

Switching cage motors: starting and switching off running motors.

The breaking current I_c for AC-3 is equal to the rated operational current I_e (I_e = motor full load current).

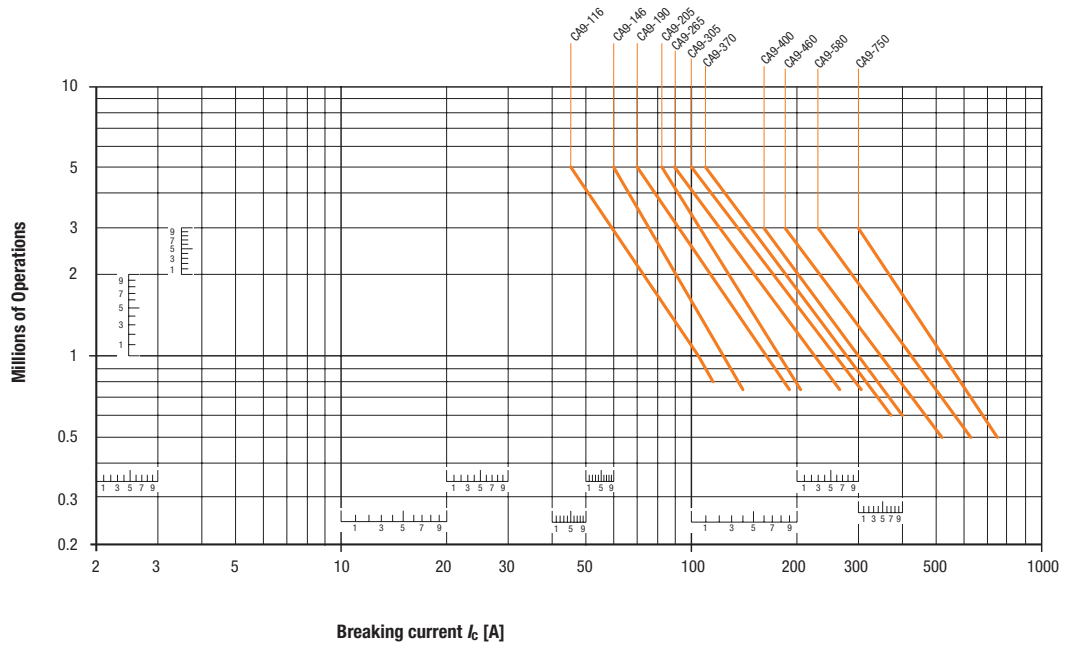

Electrical durability for AC-3 utilization category - $440V < U_e \leq 690V$ ❷

Switching cage motors: starting and switching off running motors.

The breaking current I_c for AC-3 is equal to the rated operational current I_e (I_e = motor full load current).

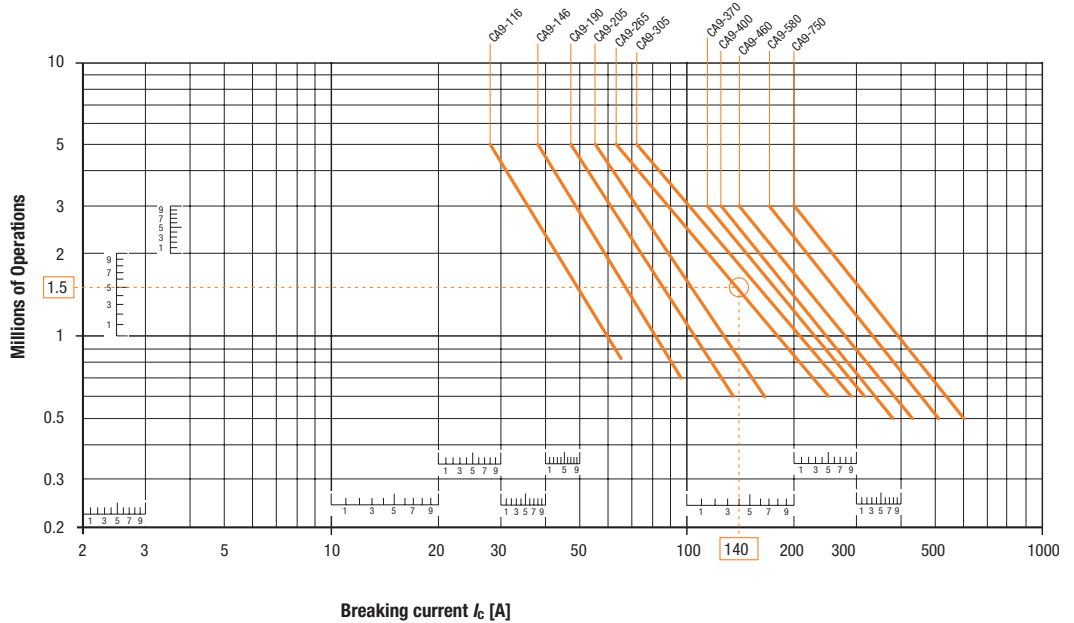

❶ CA9-860 and CA9-1060 electrical durability at the rated current is 50,000 operating cycles.

Life-Load Curves

3-Pole Contactors
Electrical Durability

Electrical durability for AC-2 or AC-4 utilization category - $U_e \leq 440V$

Switching cage motors: starting/reversing, and step-by-step operation.

The breaking current I_c is equal to $2.5 \times I_n$ for AC-2 and $6 \times I_n$ for AC-4, keeping in mind that I_n is the motor rated operational current ($I_n =$ motor full load current).

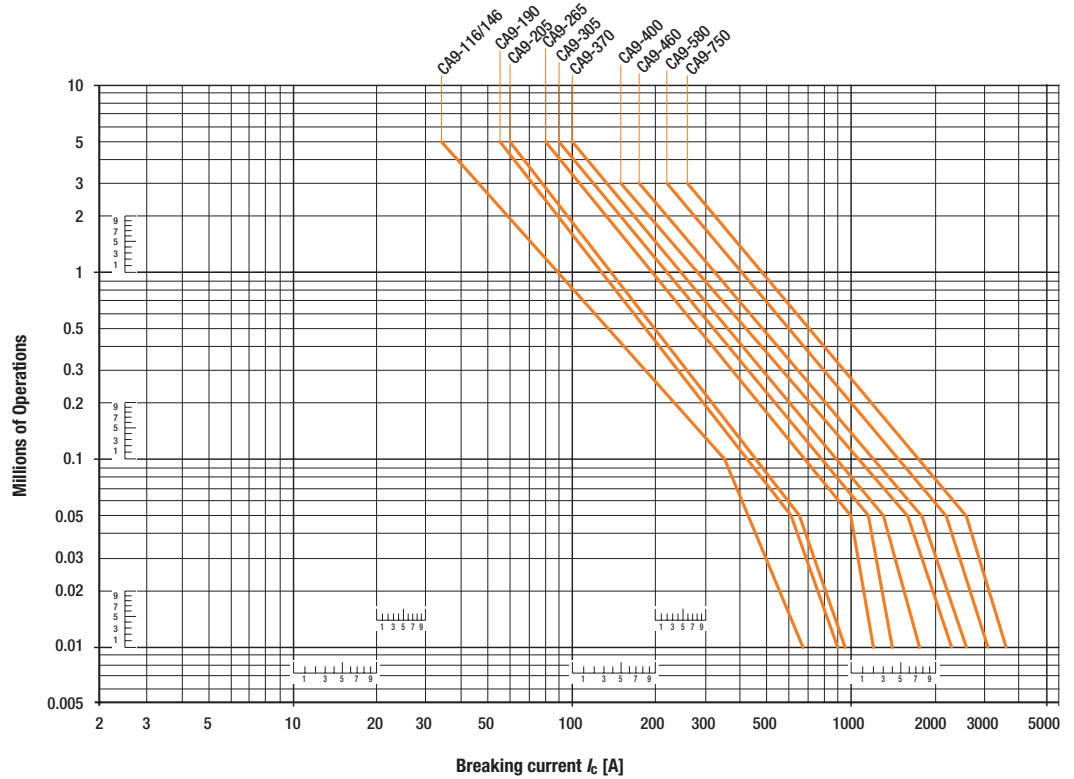

A

Life-Load Curves

3-Pole Contactors
Electrical Durability

CA9 Contactors

Electrical durability for AC-2 or AC-4 utilization category - $440V < U_e \leq 690V$
 Switching cage motors: starting/reversing, and step-by-step operation.
 The breaking current I_c is equal to $2.5 \times I_e$ for AC-2 and $6 \times I_e$ for AC-4,
 keeping in mind that I_e is the motor rated operational current ($I_e =$ motor full load current).

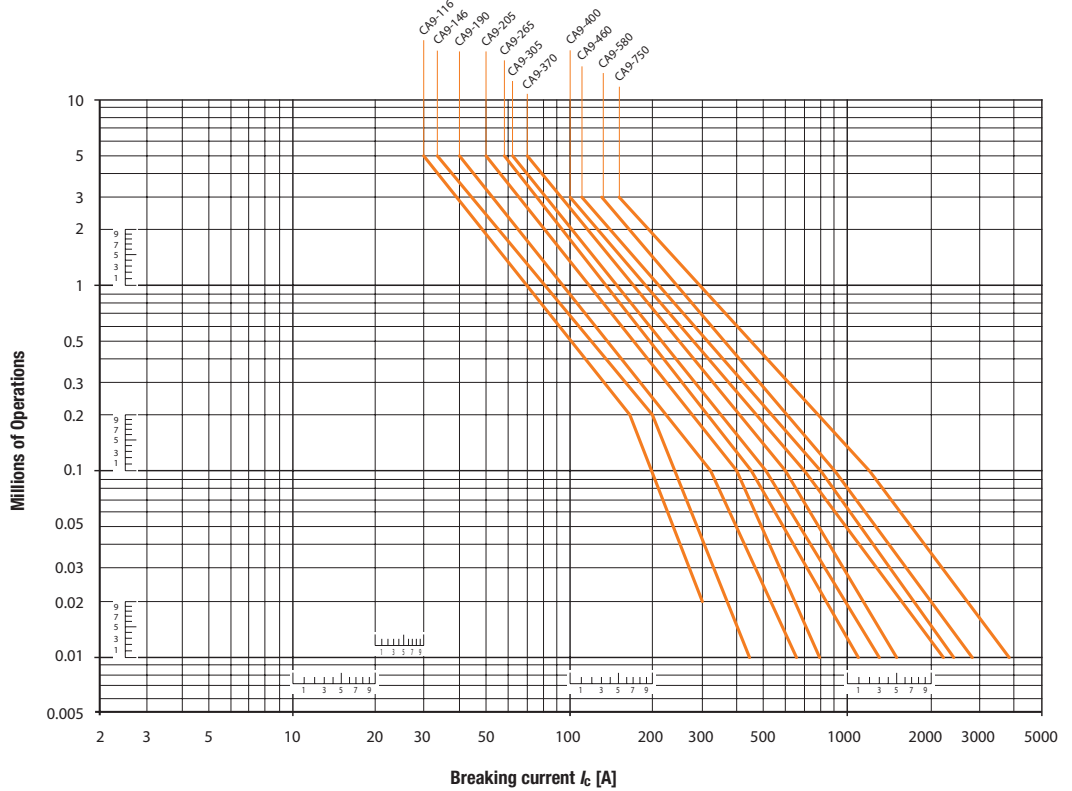

Series CA9-116...146--L (Contactors/Reversing Contactors)

Dimensions are in millimeters (inches). Dimensions not intended for manufacturing purposes.

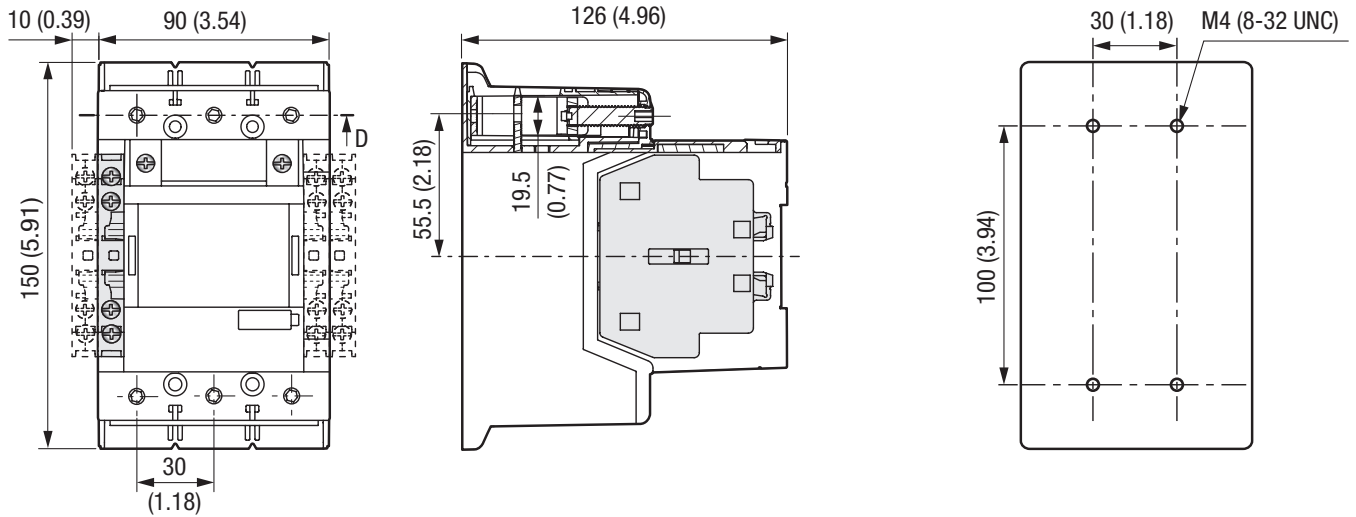

Series CA9-116-El...146-El--L (Contactors/Reversing Contactors with PLC Interface)

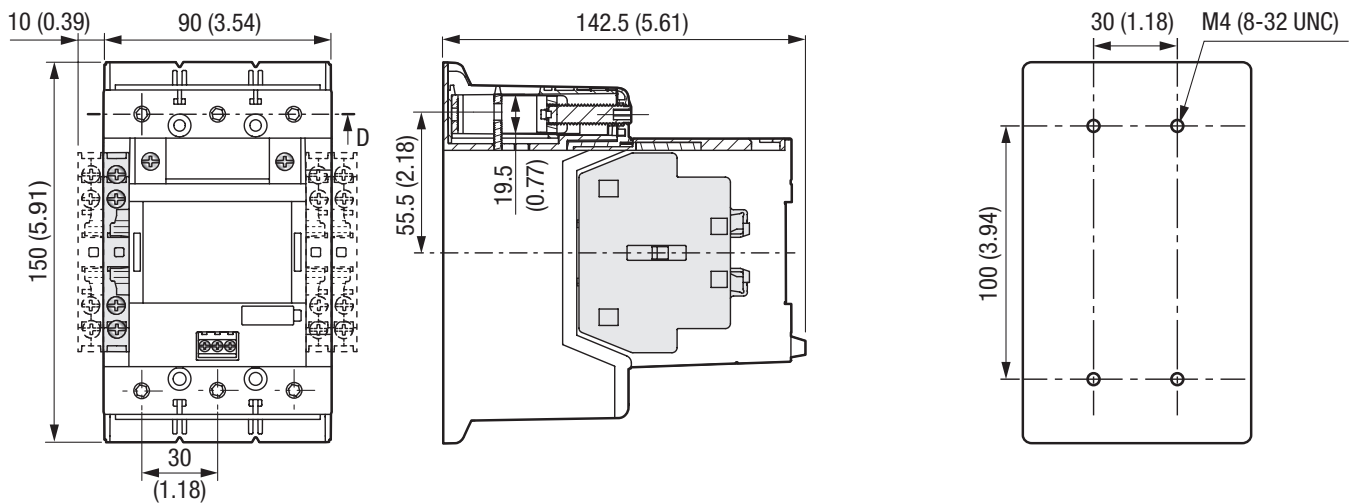

Mounting Position

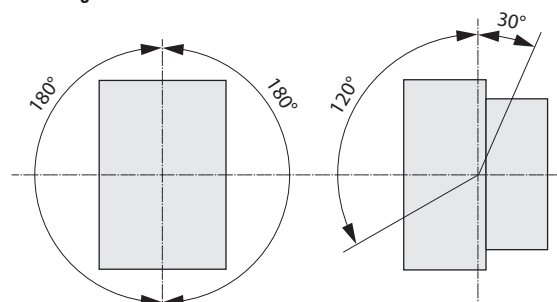

Series CA9-190...205 (Contactors/Reversing Contactors)

Dimensions are in millimeters (inches). Dimensions not intended for manufacturing purposes.

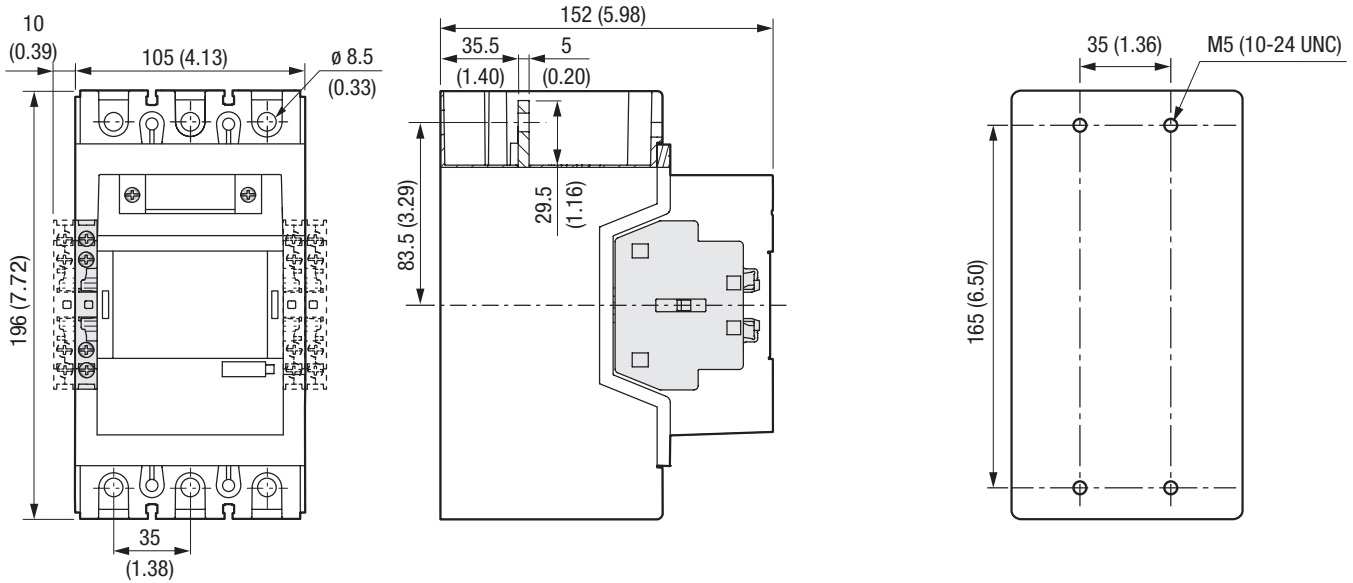

Series CA9-190-EI...205-EI (Contactors/Reversing Contactors with PLC Interface)

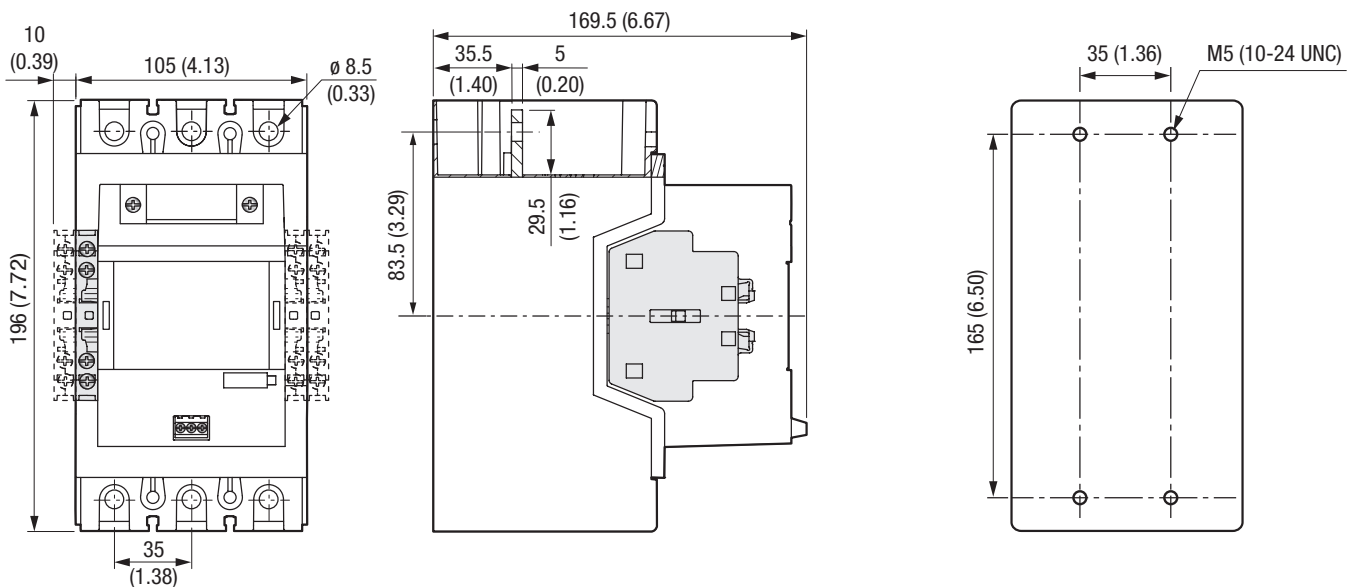

Series CA9-265...370 (Contactors/Reversing Contactors)

Dimensions are in millimeters (inches). Dimensions not intended for manufacturing purposes.

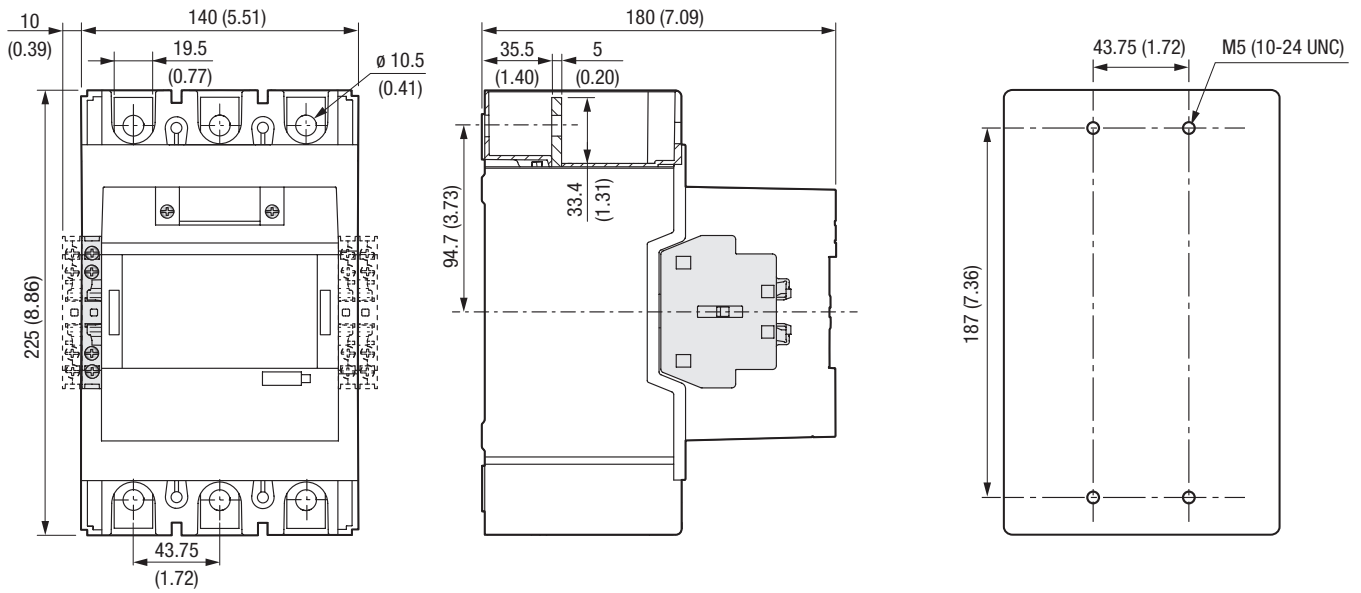

Series CA9-265-EI...370-EI (Contactors/Reversing Contactors with PLC Interface)

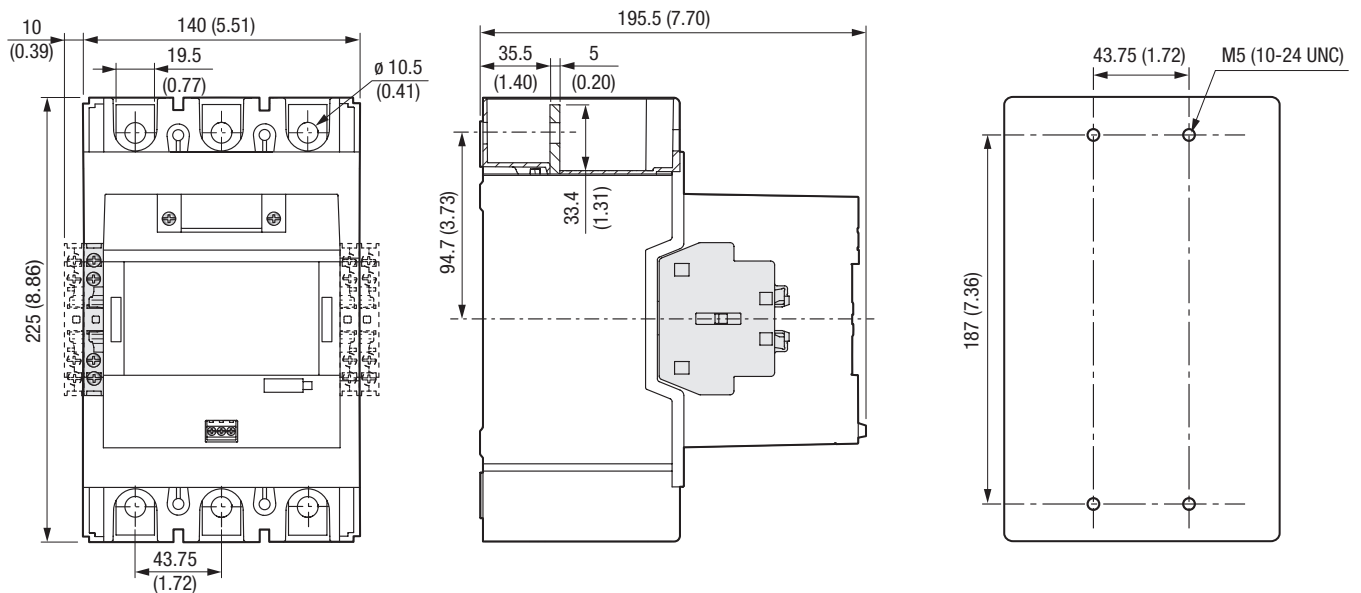

Series CA9-400-EI...460-EI (Contactors/Reversing Contactors with PLC Interface)

Dimensions are in millimeters (inches). Dimensions not intended for manufacturing purposes.

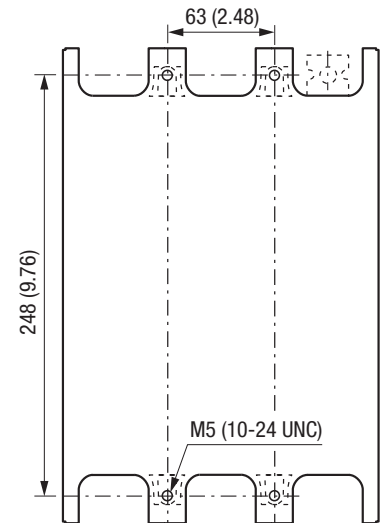
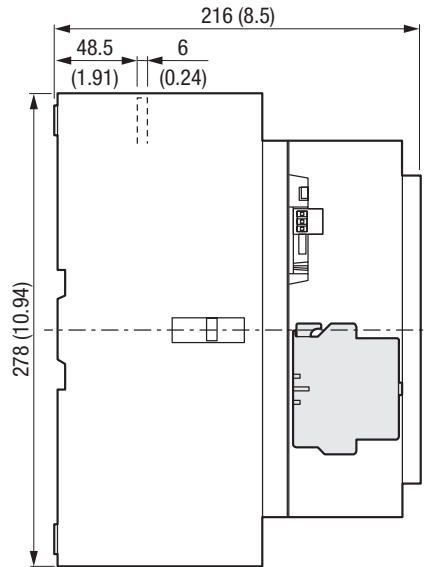
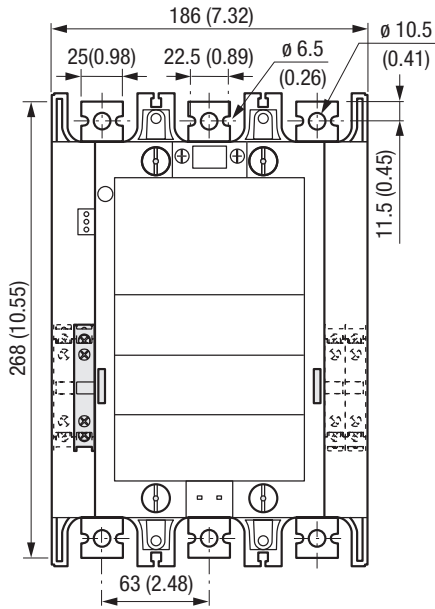

Series CA9-580-EI, CA9-750-EI (Contactors/Reversing Contactors with PLC Interface)

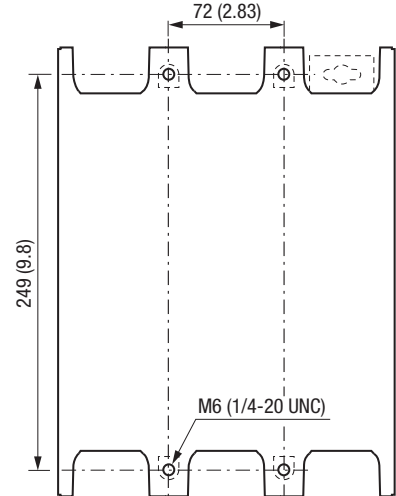
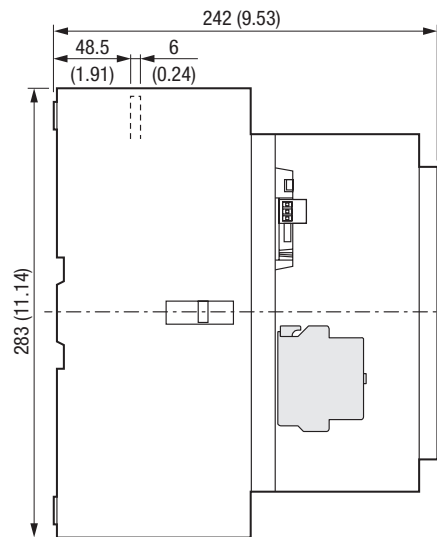
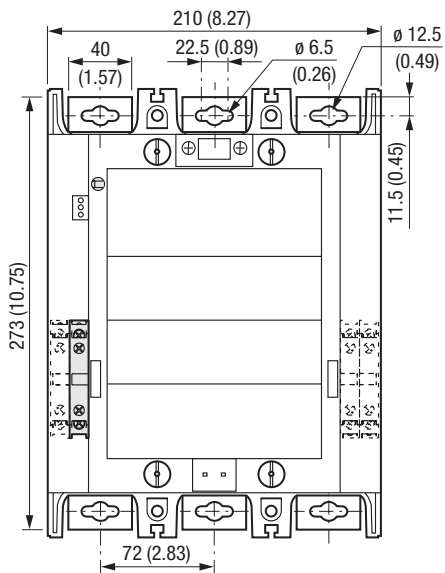

Series CA9-1260-EI (Contactors with PLC Interface)

Dimensions are in millimeters (inches). Dimensions not intended for manufacturing purposes.

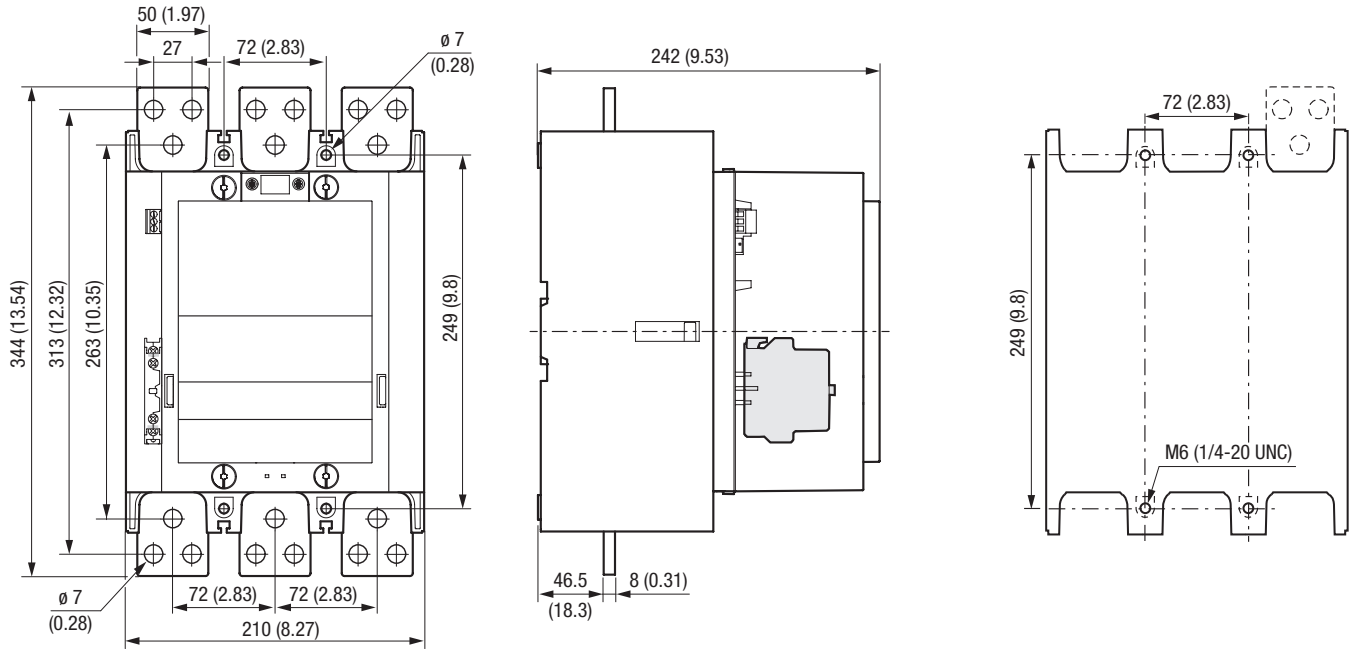

Series CA9-860-EI, CA9-1060-EI, CA9-2050-EI, CA9-2650-EI (Contactors with PLC Interface)

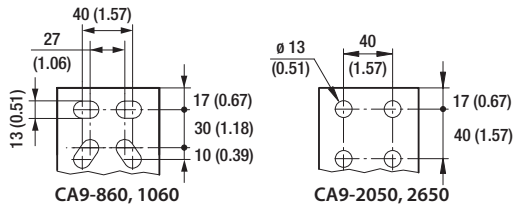

Dim	CA9-860, 1060, 2050	CA9-2650
A	392 (15.43)	422 (16.61)
B	47 (1.85)	53 (2.09)
C	10 (0.39)	25 (0.98)

