

General Purpose Relays R2N/R4N Miniature Power Plug-in Relays

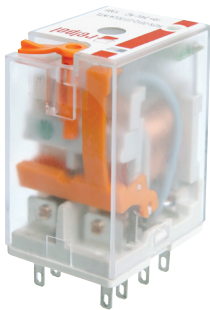

R2N Miniature Blade Type Relay

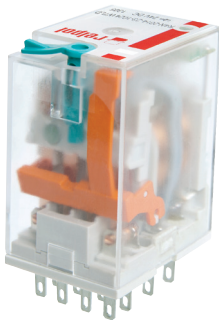

R4N Miniature Blade Type Relay



The Repol R2N and R4N General Purpose Miniature Power Relays, typically called “miniature cube type” in the industry, offer high reliability and ruggedness without sacrificing the convenience and economy users have come to expect from relays in this size class. This line of plug-in devices is well suited to any application where a dependable low cost control relay is required.

Versatile design for any application

The R2N miniature power relay is rated at 12 amps resistive @240VAC and is available in a 2PDT (2 form-C contacts) contact arrangement. The R4N relay is rated at 6 amps resistive @240VAC and available in a 4PDT (4 form-C contacts) contact design.

The relay contact materials are cadmium-free and are made of highly reliable silver nickel (AgNi) which can perform to currents as low as 5mA@5V. For lower level signal applications, the R4N is also available with silver nickel gold plated contacts for circuits 2mA.

Each relay style is available in ten coil voltages from 6V DC to 110V DC and 6V AC to 240V AC.

Extremely rugged and reliable

The R2N and R4N relays provides long lasting high quality contact reliability even after millions of operations, due to their hard silver contacts with a mechanical life of 20 million cycles, and high contact switching capacity.

Convenient features

All R Series miniature power relay features a mechanical “flag” and a one piece “push-to-test button/latching” lever. The “push-to-test” button permits a momentary testing of the relay contacts. The “latching” lever allows the relay contacts to remain closed for longer testing periods until released back to normal.

These standard features save time and labor when troubleshooting control circuitry.

A LED position indicator that shows whether the relay is energized and that the contacts have changed over is available as standard. All relays with DC coils are bi-polar, which means polarity input can either be +/- or -/+ to energize the coil.

DIN-rail mounted relay sockets

The GZT relay sockets offer a unique look in an IEC slim design style. The sockets can be DIN-mounted or screwed directly onto the panel. The socket terminals are fully opened and pin numbers are clearly identified. The relays are easily secured and fastened to the relay sockets. For high vibration applications, optional retainer clips are available to firmly hold the relays to the socket base.

Safety Approvals

The R2N and R4N are UL recognized, CSA certified, VDE certified and CE marked which meets the requirements of all important international approval organizations, making them ideal for use in both domestic and export equipment.

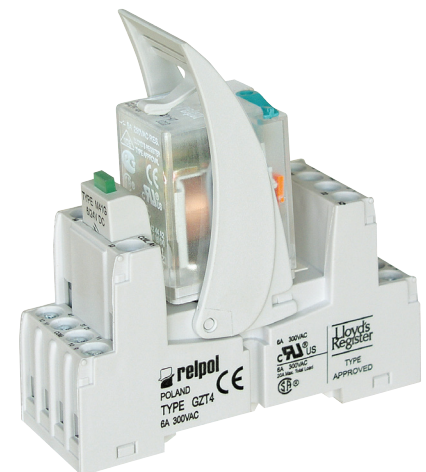

R4N relay and GZT4 socket with GZT4-0040 retainer clip

G
Repol Control Relays

Plug-in Relays 2 Pole (Form C)- Miniature Blade Type ①

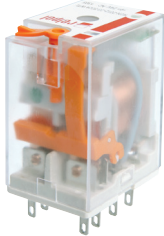
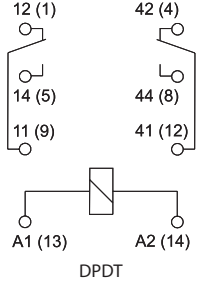
R2N Relay	Description	Position Indication	Diagram (pin side view)	Coil Voltage	Catalog Number	Pkg Qty
	12A DPTDT 2 Pole (2 Form C) Single AgNi Contact Features: Push-to-test/ Latching Lever as standard Built-in LED Bi-polar input for DC versions	Indicating Flag Electrical LED		6VDC	R2N-2012-23-1006-WTL	10
				12VDC	R2N-2012-23-1012-WTL	
				24VDC	R2N-2012-23-1024-WTL	
				48VDC	R2N-2012-23-1048-WTL	
				110VDC	R2N-2012-23-1110-WTL	
				6VAC	R2N-2012-23-5006-WTL	
				12VAC	R2N-2012-23-5012-WTL	
				24VAC	R2N-2012-23-5024-WTL	
				120VAC	R2N-2012-23-5120-WTL	
				240VAC	R2N-2012-23-5240-WTL	

Plug-in Relays 4 Pole (Form C) - Miniature Blade Type ①

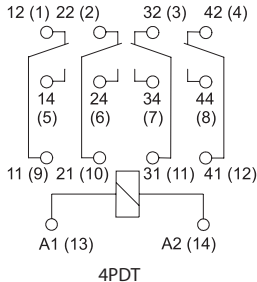

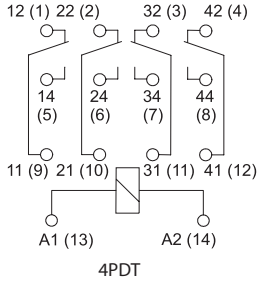

R4N Relay	Description	Position Indication	Diagram (pin side view)	Coil Voltage	Catalog Number	Pkg Qty
	6A 4PDT 4 Pole (4 Form C) AgNi Contacts Features: Push-to-test/ Latching Lever as standard Built-in LED Bi-polar input for DC versions	Indicating Flag Electrical LED		6VDC	R4N-2014-23-1006-WTL	10
				12VDC	R4N-2014-23-1012-WTL	
				24VDC	R4N-2014-23-1024-WTL	
				48VDC	R4N-2014-23-1048-WTL	
				110VDC	R4N-2014-23-1110-WTL	
				6VAC	R4N-2014-23-5006-WTL	
				12VAC	R4N-2014-23-5012-WTL	
				24VAC	R4N-2014-23-5024-WTL	
				120VAC	R4N-2014-23-5120-WTL	
				240VAC	R4N-2014-23-5240-WTL	

Plug-in Relays 4 Pole (Form C) - Miniature Blade Type, Low Level Applications ①

R4N Relay	Description	Position Indication	Diagram (pin side view)	Coil Voltage	Catalog Number	Pkg Qty
	6A 4PDT 4 Pole (4 Form C) AgNi/Au Gold Plated Contacts 2mA 5V Features: Push-to-test/ Latching Lever as standard Built-in LED Bi-polar input for DC versions	Indicating Flag Electrical LED		6VDC	R4N-2314-23-1006-WTL	10
				12VDC	R4N-2314-23-1012-WTL	
				24VDC	R4N-2314-23-1024-WTL	
				48VDC	R4N-2314-23-1048-WTL	
				110VDC	R4N-2314-23-1110-WTL	
				6VAC	R4N-2314-23-5006-WTL	
				12VAC	R4N-2314-23-5012-WTL	
				24VAC	R4N-2314-23-5024-WTL	
				120VAC	R4N-2314-23-5120-WTL	
				240VAC	R4N-2314-23-5240-WTL	

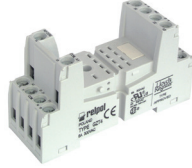
① The standard features of "Push-to-test/Latching" lever can be easily removed and plugged with an accessory plug or push-to-test only button. See installation guide and accessory plugs/push-to-test buttons on next page.

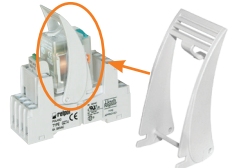
Accessories

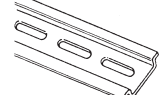
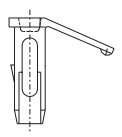
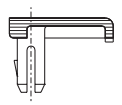
Accessory	Description	Catalog Number	Pkg Qty
	Screw Terminal, Relpol Miniature Blade-Type Socket for R2N relays - Panel or DIN-rail mounting - 14 blade miniature socket - 12A, 300V rating cURus, CSA, CE	GZT2	10
	Screw Terminal, Relpol Miniature Blade-Type Socket for R4N relays - Panel or DIN-rail mounting - 14 blade miniature socket - 6A, 300V rating cURus, CSA, CE	GZT4	10
	Retainer clip for GZT2 & GZT4 Miniature blade relay sockets	G41052	25
	Retainer/retractor clip for GZT2 & GZT4 Miniature blade relay sockets	GZT4-0040S	10
	Description plate for GZT2 & GZT4 Miniature blade relay sockets	GZT4-0035	10
	DIN-rail - 2 meter lengths (6' 6") Top Hat, low profile Top Hat, high profile	3F 3AF	20 12
	P-Type button (push-to-test button) ① See application details below. For R2N/R4N Relays with AC Coils (orange button) For R2N/R4N Relays with DC Coils (green button)	R4P-0001-A R4P-0001-D	100
	Relay hole plug. Plugs the hole when the T or P type inserts ① are removed. See installation details below. For R2N/R4N Relays with AC Coils (orange button) For R2N/R4N Relays with DC Coils (green button)	R4W-0003-A R4W-0003-D	100

Plug & P-type button (Push-to-test) for R2N and R4N Relays

The R2N and R4N relays are equipped with a one-piece "T" insert that functions either as Push-to-test button or Latching of the relay contacts as standard. The "T" insert can be easily removed and replaced with an accessory Plug for applications that can not include these additional standard features.

The accessory P-Type button (Push-to-test) is recommended for applications that only require manual contact closure for control circuit testing. By manually pressing the P-Type button, the relay contacts change state for as long as the P-Type button is pressed. Contacts return to the initial position as soon as pressure is released from the P-Type button. This operation can be done while the coil is de-energized. The standard "T" insert can be easily removed and replaced with a P-Type button as shown.



Remove the standard "T" plastic insert with a small screwdriver as shown

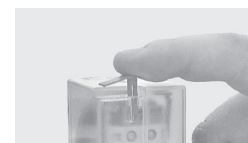

Insert the P-Type button or Plug as shown and snap down into place

① Minimum order quantity is one package of 100. Price each x 100 = total price.

R15 Plug-in Power Relays Tube Base Style

The Relpol R15 General Purpose Plug-in Power Relays offer high reliability and ruggedness in a full featured model design. This line of plug-in devices is well suited for the traditional tube base market. This is widely used in the industry where a dependable low cost control relay is required.

Designed for traditional applications

The R15 plug-in power relay is rated at 10 amps resistive @250VAC and is available in a 2PDT (2 form-C contacts) and 3PDT (3 form-C contacts) contact arrangement. The two pole and three pole relays are housed in traditional 8 pin and 11 pin designs.

The relay contact materials are cadmium-free and are made of highly reliable silver nickel (AgNi) which can perform to currents as low as 5mA@5V. The R15 relays are available in ten coil voltages from 6V DC to 110V DC and 6V AC to 240V AC.

Rugged and reliable

The R15 plug-in power relays provide long lasting high quality contact reliability even after millions of operations, due to their hard silver contacts with a mechanical life of 20 million cycles, and high contact switching capacity.

Convenient features

All R15 plug-in power relays feature a mechanical “flag” and a one piece “push-to-test button/latching” lever. The “push-to-test” button permits a momentary testing of the relay contacts. The “latching” lever allows the relay contacts to remain closed for longer testing periods until released back to normal. These standard features save time and labor when troubleshooting control circuitry.

A LED position indicator shows whether the relay is energized and the contacts have changed over is available as standard.

DIN-rail mounted relay sockets

The PZ relay sockets offer a unique look in an IEC slim design style. The sockets can be DIN-mounted or screwed directly onto the panel. The socket terminals are fully opened and pin numbers are clearly identified. The relays are easily secured and fastened to the relay sockets. For high vibration applications, optional retainer clips are available to firmly hold the relays to the socket base.

Safety Approvals

The R15 plug-in power relays are UL recognized, CSA certified, VDE certified and CE marked which meets the requirements of all important international approval organizations, making them ideal for use in both domestic and export equipment.



R15 2PDT 8-Pin Relay

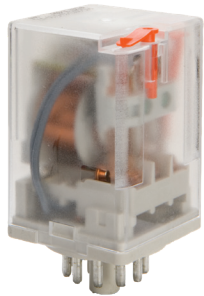

R15 3PDT 11-Pin Relay

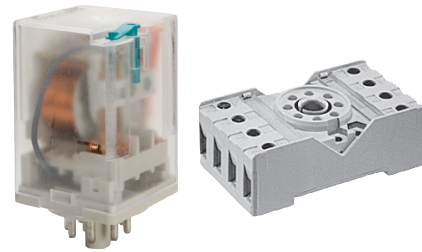

R15 2PDT relay and PZ8 socket

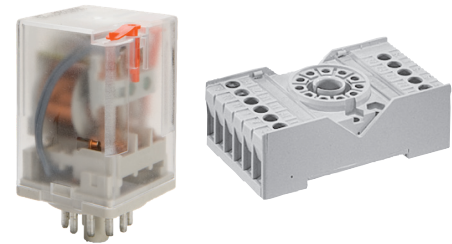

R15 3PDT relay and PZ11 socket



Plug-in Relays 2 Pole (Form C) - Tube Base 8-Pin Type ❶

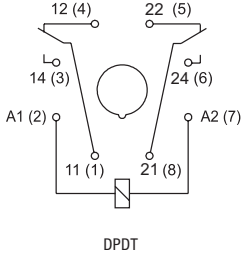

R15 Relay	Description	Position Indication	Diagram (pin side view)	Coil Voltage	Catalog Number	Pkg Qty
	10A DPDT 2 Pole (2 Form C) AgNi Contacts Features: Push-to-test/ Latching Lever as standard Built-in LED Bi-polar input for DC versions	Indicating Flag Electrical LED		6VDC	R15-2012-23-1006-WTL	10
				12VDC	R15-2012-23-1012-WTL	
				24VDC	R15-2012-23-1024-WTL	
				48VDC	R15-2012-23-1048-WTL	
				110VDC	R15-2012-23-1110-WTL	
				6VAC	R15-2012-23-5006-WTL	
				12VAC	R15-2012-23-5012-WTL	
				24VAC	R15-2012-23-5024-WTL	
				120VAC	R15-2012-23-5120-WTL	
				240VAC	R15-2012-23-5240-WTL	

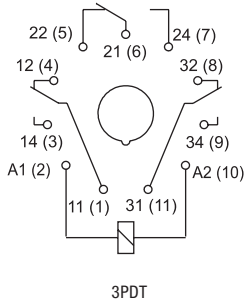
Plug-in Relays 3 Pole (Form C) - Tube Base 11-Pin Type ❶

R15 Relay	Description	Position Indication	Diagram (pin side view)	Coil Voltage	Catalog Number	Pkg Qty
	10A 3PDT 3 Pole (3 Form C) AgNi Contacts Features: Push-to-test/ Latching Lever as standard Built-in LED Bi-polar input for DC versions	Indicating Flag Electrical LED		6VDC	R15-2013-23-1006-WTL	10
				12VDC	R15-2013-23-1012-WTL	
				24VDC	R15-2013-23-1024-WTL	
				48VDC	R15-2013-23-1048-WTL	
				110VDC	R15-2013-23-1110-WTL	
				6VAC	R15-2013-23-5006-WTL	
				12VAC	R15-2013-23-5012-WTL	
				24VAC	R15-2013-23-5024-WTL	
				120VAC	R15-2013-23-5120-WTL	
				240VAC	R15-2013-23-5240-WTL	

❶ The standard features of “Push-to-test/Latching” lever can be easily removed and plugged with an accessory plug or push-to-test button. See installation guide and accessory plugs/push-to-test buttons on page G49.

Accessories

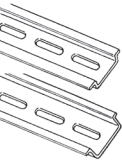
Accessory	Description	Catalog Number	Pkg Qty
	Screw Terminal, Relpol Tube Base 8-PIN Socket for R15 relays - Panel or DIN-rail mounting - 10A, 250V rating, UR, CSA	PZ8	10
	Screw Terminal, Relpol Tube Base 11-PIN Socket for R15 relays - Panel or DIN-rail mounting - 10A, 250V rating, UR, CSA	PZ11	10
	Retainer clip for PZ8 & PZ11 tube base relay sockets	PZ11-0031	25
	DIN-rail - 2 meter lengths (6' 6") Top Hat, low profile Top Hat, high profile	3F 3AF	20 12

Accessories

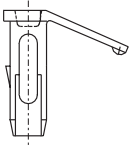
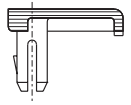
Accessory	Description	Catalog Number	Pkg Qty
	<p>P-Type button (push-to-test button) ❶</p> <p>See application details below.</p> <p>For R15 Relays with AC Coils (orange button)</p> <p>For R15 Relays with DC Coils (green button)</p>	<p>R15-M404-A</p> <p>R15-M404-D</p>	100
	<p>Relay hole plug. Plugs the hole when the T or P type inserts ❶ are removed. See installation details below.</p> <p>For R15 Relays with AC Coils (orange button)</p> <p>For R15 Relays with DC Coils (green button)</p>	<p>R15-M203-A</p> <p>R15-M203-D</p>	100

Plug & P-type button (Push-to-test) for R15 Relays

The R15 relays are equipped with a one-piece “T” insert that functions either as Push-to-test button or Latching of the relay contacts as standard. The “T” insert can be easily removed and replaced with an accessory Plug for applications that can not include these additional standard features.

The accessory P-Type button (Push-to-test) is recommended for applications that only require manual contact closure for control circuit testing. By manually pressing the P-Type button, the relay contacts change state for as long as the P-Type button is pressed. Contacts return to the initial position as soon as pressure is released from the P-Type button. This operation can be done while the coil is de-energized. The standard “T” insert can be easily removed and replaced with a P-Type button as shown.



Remove the standard “T” plastic insert with a small screwdriver as shown

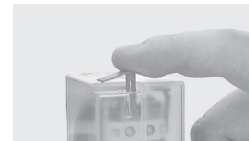

Insert the P-Type button or Plug as shown and snap down into place

❶ Minimum order quantity is one package of 100. Price each x 100 = total price.

RUC Plug-in Power Relays Square Base Plug-in

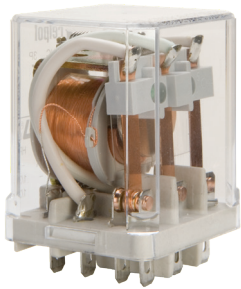

RUC 3PDT Blade Type relay



The Relpol RUC General Purpose Plug-in Power Relays offer high reliability and robustness in a traditional square base design. This line of plug-in devices is well suited for the traditional higher inrush current applications.

Designed for higher amps and inrush applications

The RUC plug-in power relay is rated at 15 amps resistive @250VAC and is available in a 2PDT (2 form-C contacts). It is also available in a 3PDT (3 form-C contacts) contact arrangement rated at 10 amps resistive @250VAC. These relays can handle inrush currents up to 40 amps.

The relay contact materials are made of highly reliable silver tin (AgSnO₂) which has a minimum switching capacity of 10mA @10V. The RUC relays are available in ten coil voltages from 6V DC to 110V DC and 6V AC to 240V AC.

Rugged and reliable

The RUC plug-in power relays provide long lasting high quality contact reliability even after millions of operations due to their hard nickel cadmium contacts, with a mechanical life of 20 million cycles, and high contact switching capacity.

Convenient features

The RUC plug-in power relay offers a LED position indicator that shows whether the relay is energized and that the contacts have changed over.

DIN-rail mounted relay sockets

The SB11 relay sockets offer a traditional look in an IEC design. The sockets can be DIN-mounted or screwed directly onto the panel. The terminal pin numbers are clearly identified. The relays are easily secured and fastened to the relay sockets. For high vibration applications, optional retainer clips are available to firmly hold the relays to the socket base.

Safety Approvals

The RUC plug-in power relays are UL recognized, CSA certified and CE marked which meets the requirements of all important international approval organizations, making them ideal for use in both domestic and export equipment.

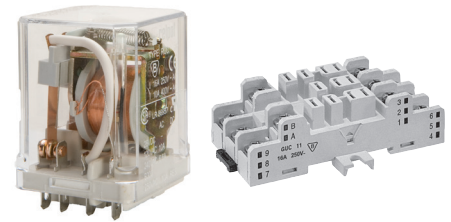

RUC 3PDT relay and SB11 socket

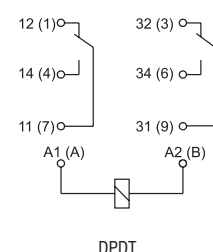

Plug-in Relays 2 Pole (Form C) - Square Base Blade Type ①

RUC Relay	Description	Position Indication	Diagram (pin side view)	Coil Voltage	Discontinued	Catalog Number	Pkg Qty
	15A DPDT 2 Pole (2 Form C) AgSnO ₂ Contacts Features: Built-in LED Bi-polar input for DC versions	Indicating Flag Electrical LED		6VDC	RUC-1012-26-1006-L	RUC-3012-26-1006-L	10
				12VDC	RUC-1012-26-1012-L	RUC-3012-26-1012-L	
				24VDC	RUC-1012-26-1024-L	RUC-3012-26-1024-L	
				48VDC	RUC-1012-26-1048-L	RUC-3012-26-1048-L	
				110VDC	RUC-1012-26-1110-L	RUC-3012-26-1110-L	
				6VAC	RUC-1012-26-5006-L	RUC-3012-26-5006-L	
				12VAC	RUC-1012-26-5012-L	RUC-3012-26-5012-L	
				24VAC	RUC-1012-26-5024-L	RUC-3012-26-5024-L	
				120VAC	RUC-1012-26-5120-L	RUC-3012-26-5120-L	
				240VAC	RUC-1012-26-5240-L	RUC-3012-26-5240-L	

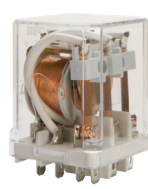
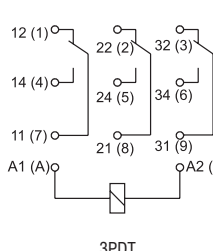
Plug-in Relays 3 Pole (Form C) - Square Base Blade Type ①

RUC Relay	Description	Position Indication	Diagram (pin side view)	Coil Voltage	Discontinued	Catalog Number	Pkg Qty
	10A 3PDT 3 Pole (3 Form C) AgSnO ₂ Contacts Features: Built-in LED Bi-polar input for DC versions	Indicating Flag Electrical LED		6VDC	RUC-1013-26-1006-L	RUC-3013-26-1006-L	10
				12VDC	RUC-1013-26-1012-L	RUC-3013-26-1012-L	
				24VDC	RUC-1013-26-1024-L	RUC-3013-26-1024-L	
				48VDC	RUC-1013-26-1048-L	RUC-3013-26-1048-L	
				110VDC	RUC-1013-26-1110-L	RUC-3013-26-1110-L	
				6VAC	RUC-1013-26-5006-L	RUC-3013-26-5006-L	
				12VAC	RUC-1013-26-5012-L	RUC-3013-26-5012-L	
				24VAC	RUC-1013-26-5024-L	RUC-3013-26-5024-L	
				120VAC	RUC-1013-26-5120-L	RUC-3013-26-5120-L	
				240VAC	RUC-1013-26-5240-L	RUC-3013-26-5240-L	

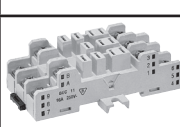
Accessories

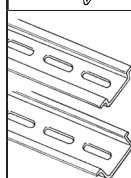
Accessory	Description	Catalog Number	Pkg Qty
	Screw Terminal, Square Base Blade type Socket for RUC relays - Panel or DIN-rail mounting ② - 15A, 300VAC rating, UR, CSA	SB11	10
	Retainer clip for SB11 tube base relay sockets	MBA	25
	DIN-rail - 2 meter lengths (6' 6") Top Hat, low profile Top Hat, high profile	3F 3AF	20 12

① Relays can be special ordered with No LED's, contact your Sprecher + Schuh representative.

② This product is sourced from a third party manufacturer, not Repol.

RY2 Plug-in Power Relays Slim Square Base

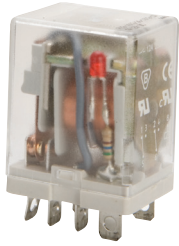

RY2 2PDT Blade Type Relay



The Relpol RY2 General Purpose Plug-in Power Relay is a traditional square base blade type style designed for higher current application in a small design.

Designed for higher amp applications in a reduced size

The RY2 plug-in power relay is rated at 12 amps resistive @250VAC and is available in a 2PDT (2 form-C contacts). These relays can handle inrush currents up to 20 amps in a small packaged design.

The relay contact materials are made of highly reliable silver nickel which has a minimum switching capacity of 5mA@5V. The RY2 relays are available in ten coil voltages from 6V DC to 110V DC and 6V AC to 240V AC.

Rugged and reliable

With a mechanical life of 20 million cycles, and high contact switching capacity due to their hard nickel cadmium contacts, the RY2 plug-in power relay provides long lasting high quality contact reliability even after millions of operations.

Convenient features

All RY2 plug-in power relays feature a mechanical “flag” indicator and a LED position indicator that shows whether the relay is energized and that the contacts have changed over.

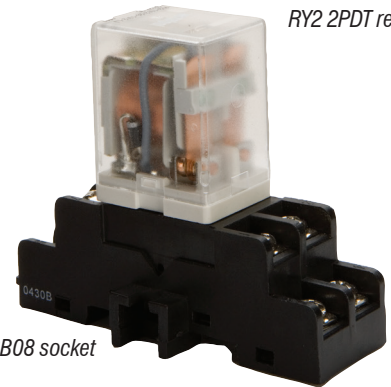

RY2 2PDT relay

SB08 socket

DIN-rail mounted relay sockets

The SB08 relay sockets offer a slim space savings design. The sockets can be DIN-mounted or screwed directly onto the panel. The terminal pin numbers are clearly identified. The relays are easily secured and fastened to the relay sockets. For high vibration applications, optional retainer clips are available to firmly hold the relays to the socket base.

Safety Approvals

The RY2 plug-in power relays are cURus recognized and CE marked which meets the requirements of all important international approval organizations, making them ideal for use in both domestic and export equipment.

Plug-in Relays 2 Pole (Form C) - Slim Blade Type

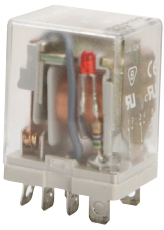
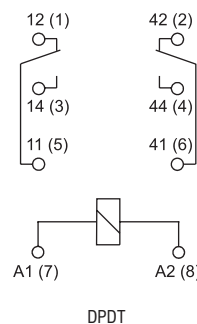
RY2 Relay	Description	Position Indication	Diagram (pin side view)	Coil Voltage	Catalog Number	Pkg Qty
	12A DPDT 2 Pole (2 Form C) AgNi Contact Features: Built-in LED Bi-polar input for DC versions	Indicating Flag Electrical LED		6VDC	RY2-2012-26-1006-L	10
				12VDC	RY2-2012-26-1012-L	
				24VDC	RY2-2012-26-1024-L	
				48VDC	RY2-2012-26-1048-L	
				110VDC	RY2-2012-26-1110-L	
				6VAC	RY2-2012-26-5006-L	
				12VAC	RY2-2012-26-5012-L	
				24VAC	RY2-2012-26-5024-L	
				120VAC	RY2-2012-26-5120-L	
				240VAC	RY2-2012-26-5240-L	

Accessories

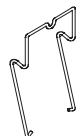
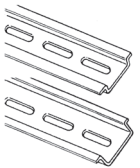
Accessory	Description	Catalog Number	Pkg Qty
	Screw Terminal, Square Base Blade type Socket for RY2 relays - Panel or DIN-rail mounting ❶ - 15A, 300VAC rating, UR, CSA	SB08	10
	Retainer clip for GZY2 tube base relay sockets	SP-8	25
	DIN-rail - 2 meter lengths (6' 6") Top Hat, low profile Top Hat, high profile	3F 3AF	20 12

❶ This product is sourced from a third party manufacturer, not Repol.

Interface PCB Relays PI84/PI85



RM84 Interface PCB Relay used in PI84 complete assembly



RM85 Interface PCB Relay used in PI85 complete assembly



The Repol PI84/PI85 Interface PCB Relays offer a unique design for high current applications. The low current input and power consumption with load capabilities of high current switching is ideal for limited input sources and panel space savings.

A full featured model in one small package

The PI84/PI85 interface PCB relays are offered as a complete package which includes the following five factory installed pieces:

1. PCB (Printed Circuit Board module)
2. Relay socket
3. LED position indicator
4. Retainer clip
5. Description plate

Low input current, high switching capabilities

The PI84 interface PCB relays is rated at 8 amps resistive @250VAC and is available in a 2PDT (2 form-C contacts). The PI85 is rated at 16 amps resistive @250VAC and is available in a SPDT (1 form-C contact). The coil power consumption is approximately 750mA AC or 480mW DC.

Both interface relay styles are available in 24V DC, 24V AC and 120V AC models.

Rugged and reliable

With a mechanical life of 20 million cycles, and high contact switching capacity due to their hard nickel cadmium contacts, the PI84/PI85 interface PCB relays provide long lasting high quality contact reliability even after millions of operations.

DIN-rail mounted relay sockets

The PI84/PI85 interface relay DIN-mounted sockets offer a slim space savings design. The relay socket includes a retainer clip to firmly hold the PCB relay and a description plate as standard.

Safety Approvals

The RM84 & RM85 interface PCB relays are UL recognized, CSA, VDE certified and CE marked which meets the requirements of all important international approval organizations, making them ideal for use in both domestic and export equipment.

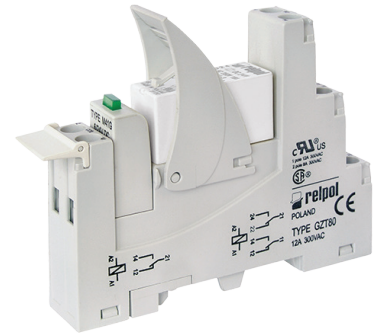

PI84 Interface PCB Relay complete assembly

Interface PCB Relays (Form C) - 2 Pole

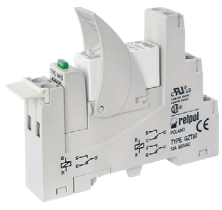
PI84 PCB Relay	Description	Position Indication	Coil Voltage	Discontinued	Catalog Number	Pkg Qty
	8A DPDT 2 Pole (2 Form C) AgNi Contacts Includes: PCB relay, plug-in socket, protective module, retainer clip and description plate	Electrical LED	24VDC	PI84-24DC-M41G	PI84-024DC-M41G-TS-2012	10
			24VAC	PI84-24AC-M91G	PI84-024AC-M91G-TS-2012	
			120VAC	PI84-120AC-M93G	PI84-120AC-M93G-TS-2012	

Interface PCB Relays (Form C) - 1 Pole

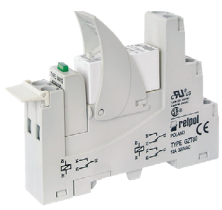
PI85 PCB Relay	Description	Position Indication	Coil Voltage	Discontinued	Catalog Number	Pkg Qty
	16A SPDT 1 Pole (1 Form C) AgNi Contacts Includes: PCB relay, plug-in socket, protective module, retainer clip and description plate	Electrical LED	24VDC	PI85-24DC-M41G	PI85-024DC-M41G-TS-2011	10
			24VAC	PI85-24AC-M91G	PI85-024AC-M91G-TS-2011	
			120VAC	PI85-120AC-M93G	PI85-120AC-M93G-TS-2011	

Accessories

RM84/RM85	Description	For use with...	Catalog Number	Pkg Qty
 RM85	Replacement PCB Relay Replacement operational relays for PI84/PI85 Interface PCB Relays	PI84-024DC-M41G	RM84-2012-25-1024	20
		PI84-024AC-M91G	RM84-2012-25-5024	
		PI84-120AC-M93G	RM84-2012-25-5120	
		PI85-024DC-M41G	RM85-2011-25-1024	20
		PI85-024AC-M91G	RM85-2011-25-5024	
		PI85-120AC-M93G	RM85-2011-25-5120	

PIR6W Slim Interface Terminal Block Relays

The Repol PIR6W Slim Interface Terminal Block Relay is ideally compact, designed for a variety of high-density isolation and interposing applications.

A full featured model in one small package

The PIR6W slim interface relays are offered as a complete package which includes the following:

- Changeover relay, rated load 6 A / 230 V (ACI)
- Interface Relay socket with built-in LED position indicator
- Description plate

Low input current, high switching capabilities

The PIR6W slim interface relay contacts are rated at 6 amps resistive @230VAC and available in SPDT (1 form - C contact). The minimum contact current capabilities are 100mA at 24V. The coil power consumption is approximately 0.3...0.8VA AC or 0.3...0.9W DC. The PIR6W interface relays are available in 24V DC, 24V AC/DC and 120V models.



PIR6W Slim Interface Relay
Complete Assembly

Rugged and reliable

With a mechanical life of 20 million cycles, and high contact switching capacity due to their silver tin oxide (AgSnO₂) contacts, the PIR6W interface relays provide long lasting high quality contact reliability even after millions of operations.

DIN-rail mounted

The PIR6W slim interface relays are DIN-rail mountable which can be easily installed along side other control terminal blocks for a space saving design.

Safety approvals

The PIR6W slim interface relays are cURus, VDE and CE marked which meets the requirements of all important international approval organizations, making them ideal for use in both domestic and export equipment.

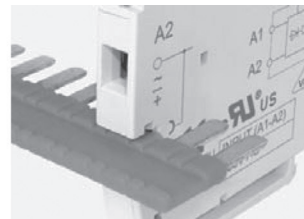

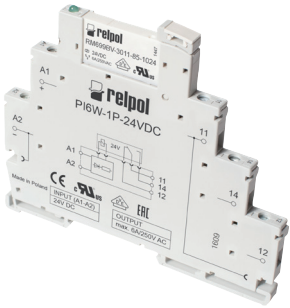
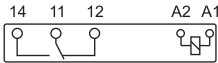

Interface Terminal Block Relays (1 Form C) - 1 Pole ①

PIR6W	Specifications	Input Voltage	Catalog Number	Pkg Qty
	 <p>6A SPDT 1 Pole (1 Form C) AgSnO₂</p> <p>Includes: – Change over relay with built-in Green LED indicator</p>	12VDC	PIR6W-1P-12VDC	10
		24VDC	PIR6W-1P-24VDC	
		24V AC/DC	PIR6W-1P-24VAC/DC	
		115V AC/DC	PIR6W-1P-115VAC/DC	

* Gray denotes special order.

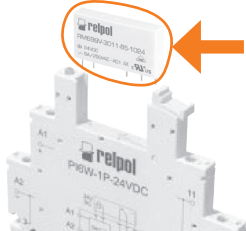
Accessories

Accessory	Description	For use with...	Catalog Number	Pkg Qty
	<p>Interface Operational Relay ② Replacement operational relays for PIR6W Interface Terminal Block Relays</p>	PIR6W-1P-12VDC	RM699BV-3011-85-1012	20
		PIR6W-1P-24VDC PIR6W-1P-24VAC/DC ③ PIR6W-1P-115VAC/DC	RM699BV-3011-85-1024	
	<p>20-Way Jumper Can be cut to required length 36A max per 20-way Jumper</p>	Red Black Blue	ZG20-1 ZG20-2 ZG20-3	20
	<p>Replacement Description Plates Allows user to label individual PIR6W Relays (one included with PIR6W-1P Relays)</p>	PIR6W-1P...	PI6W-1246	100

- ① Other input voltages available as special order; contact your Sprecher + Schuh Representative.
- ② It should be noted that rated voltage Un of the input/operational relay coil does not always comply with the rated voltage Un of the interface relay (which is important on ordering operational relays for sockets).
- ③ Previously accepted older model RM699V-3011-85-1012 12VDC replacement relay. Now supports a 24VDC relay model RM699BV-3011-85-1024.
- ④ In March 2016, Repol changed the DIN-rail fixing place location as represented in this view.

G
Repol Control Relays

Technical Information

		R2N	R4N
Contacts			
Contact number & arrangement		DPDT	4PDT
Contact material		AgNi	AgNi, AgNi/Au 5 μm
Max. switching voltage	AC/DC	250 V / 250 V	250 V / 250 V
Min. switching voltage		5 V	5 V
Rated load	AC1	12 A / 250 V AC	6 A / 250 V AC
	AC15	3 A / 120 V	1.5 A / 120 V
		1.5 A / 240 V (B300)	0.75 A / 240 V (C300)
	AC3	370 W (Single-phase motor)	125 W (Single-phase motor)
	DC1	12 A / 24 V DC	6 A / 24 V DC
	DC13	0.22 A / 120 V DC	0.22 A / 120 V DC
		0.1 A / 250 V (R300)	0.1 A / 250 V (R300)
Min. switching current		5 mA AgNi	2 mA AgNi/Au 5 μm
Max. inrush current		24 A	12 A
Rated current		12 A	6 A
Max. breaking capacity	AC1	3 000 VA	1 500 VA
Min. breaking capacity		0,3 W AgNi	0,3 W AgNi, 0,1 W AgNi/Au 5 μm
Resistance		≤ 100 mΩ	
Max. operating frequency			
• at rated load	AC1	1 200 cycles/hour	
• no load		18 000 cycles/hour	
General data			
Operating time (typical value)			
Release time (typical value)		AC: 10 ms DC: 13 ms	
Electrical life		AC: 8 ms DC: 3 ms	
	• resistive AC1	≥ 10 ⁵ 12 A, 250 V AC	≥ 10 ⁵ 6 A, 250 V AC
• cos φ		see graphs on page G67	
Mechanical life (cycles)		≥ 2 x 10 ⁷	
Dimensions (L x W x H)		27,5 x 21,2 x 35,6 mm	
Weight		35 g	
Ambient temperature			
• storing		-40...+85 °C	
• operating		AC: -40...+55 °C DC: -40...+70 °C	
Cover protection category		IP 40	
Shock resistance	(NO/NC)	10 g / 5 g	
Vibration resistance		5 g 10...150 Hz	
Solder bath temperature		max. 270 °C	
Soldering time		max. 5 s	
Insulation			
Insulation category		C250	B250
Insulation rated voltage		250 V AC	
Dielectric strength			
	• coil - contact	2 500 V AC	
• contact - contact		1 500 V AC	
• pole - pole		2,500 V AC	2,000 V AC
Contact - coil distance			
• clearance		≥ 2,5 mm	≥ 1,6 mm
• creepage		≥ 4 mm	≥ 3,2 mm
UL/CSA Ratings			
Contact Ratings, General Purpose		10A 250V AC 12A 150V AC	6A 250VAC
DC Rating		10A 28V DC	
UL File Number		E105728	
CSA File Number		LR86957	
Standards		UL 508, CAN/CSA-C22.2 No. 14	

G
Relpol Control Relays

Technical Information

		R2N	R4N
Coil			
Rated voltage	50/60 Hz AC		6...240 V
Contact material	DC		6...110 V
Must release voltage		AC: $\geq 0,2 U_n$ DC: $\geq 0,1 U_n$	
Operating range of supply voltage		see tables below	
Rated power consumption	AC		1,6 VA
	DC		0,9 W

Coil Data - AC 50/60 Hz voltage version

Coil Code	Rated Voltage V AC	Coil Resistance ($\pm 10\%$) at 20 °C	Coil Operating Range V AC	
			min. (at 20 °C)	max. (at 55 °C)
5006	6	9,8	4,8	6,6
5012	12	39,5	9,6	13,2
2024	24	158,0	19,2	26,4
5120	120	3 770,0	96,0	132,0
5240	240	16 800,0	192,0	264,0

Coil Data - DC voltage version

Coil Code	Rated Voltage V DC	Coil Resistance ($\pm 10\%$) at 20 °C	Coil Operating Range V DC	
			min. (at 20 °C)	max. (at 55 °C)
1006	6	40	4,8	6,6
1012	12	160	9,6	13,2
1024	24	640	19,2	26,4
1048	48	2600	38,4	52,8
1110	110	13 600	88,0	121,0

R2N Connections Diagram

(pin side view)

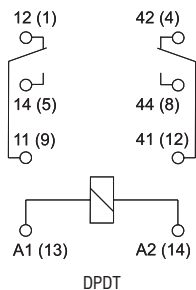
R4N-2014 Connections Diagram

(pin side view)

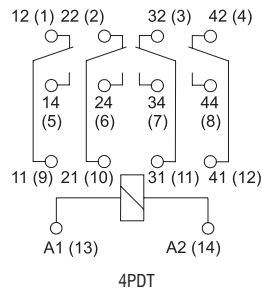
R4N-2314 Connections Diagram

(pin side view)

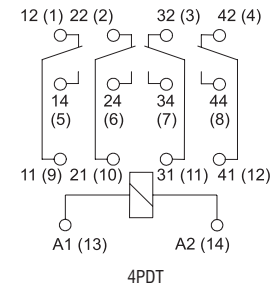

Note: Bi-polar input for DC versions

R2N

R4N

Electrical life at AC resistive load

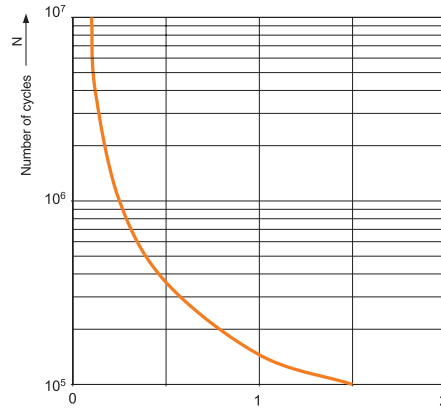
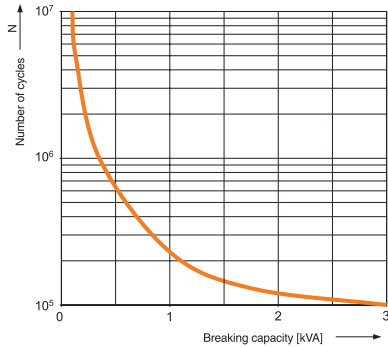
Electrical life at AC resistive load



Electrical life reduction factor at AC inductive load

Electrical life reduction factor at AC inductive load

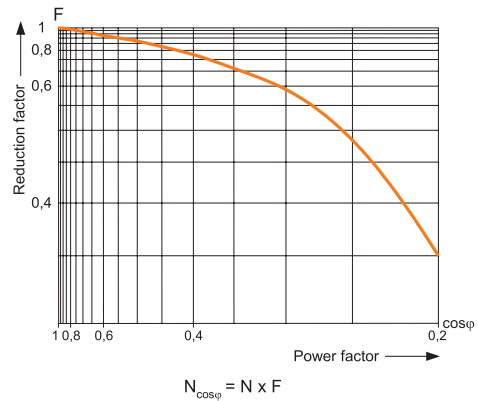
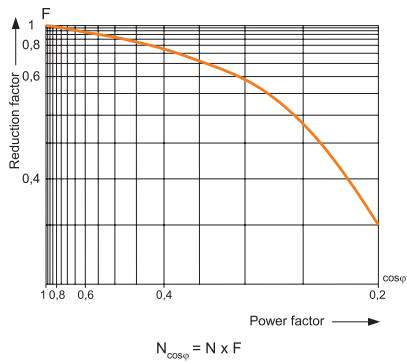

Maximum DC resistive load breaking capacity

Maximum DC resistive load breaking capacity

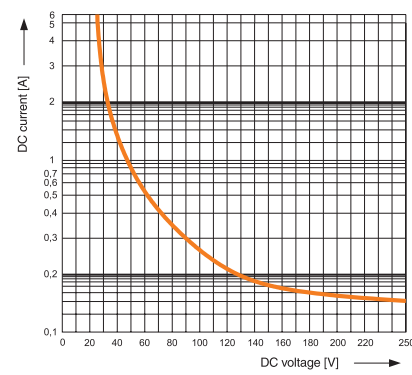
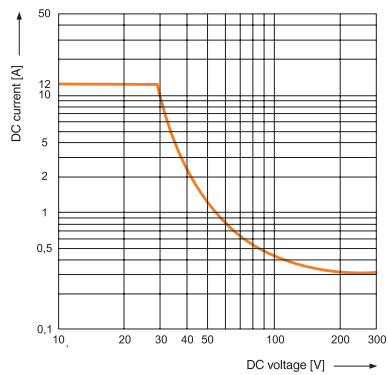

Dimensions are in millimeters (inches). Dimensions not intended for manufacturing purposes.

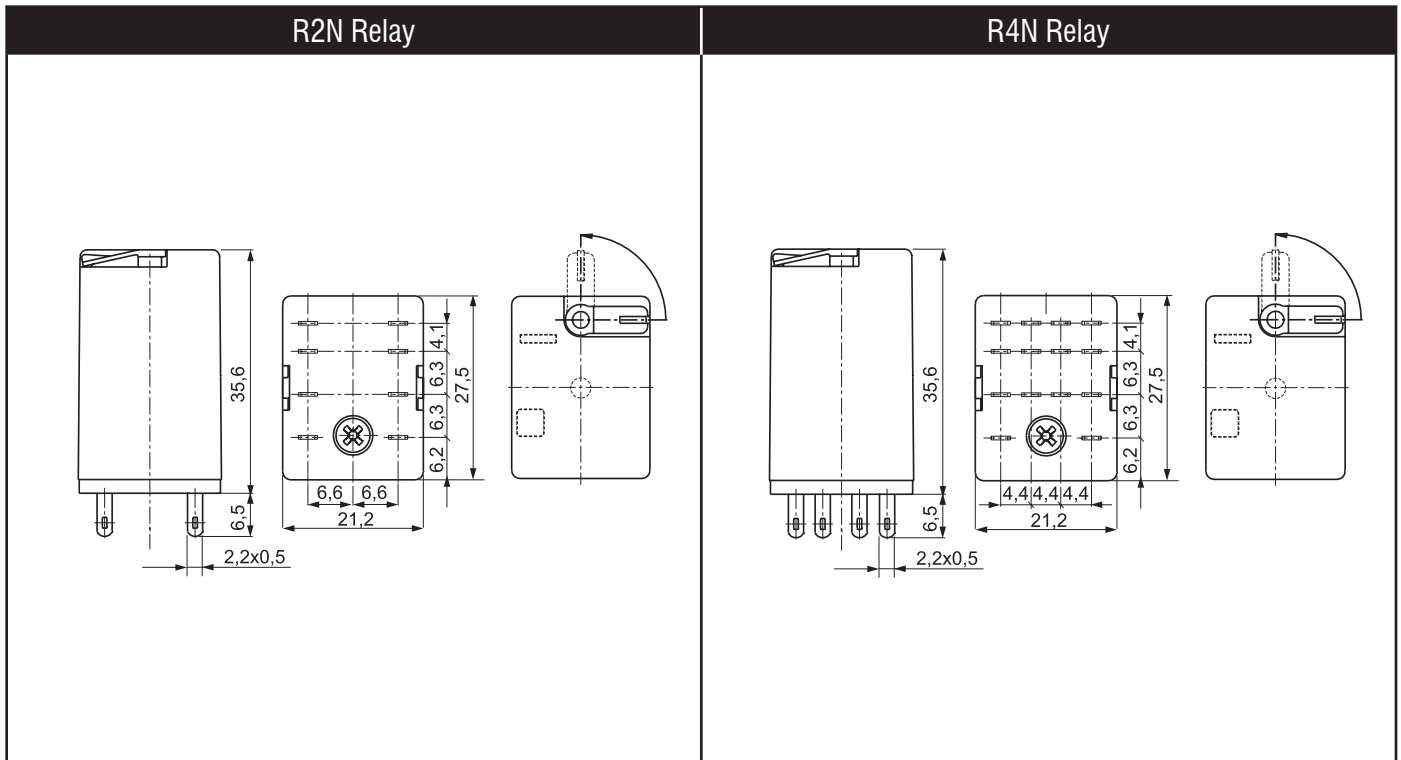

Retainer/Retractor Clip GZT4-0040S

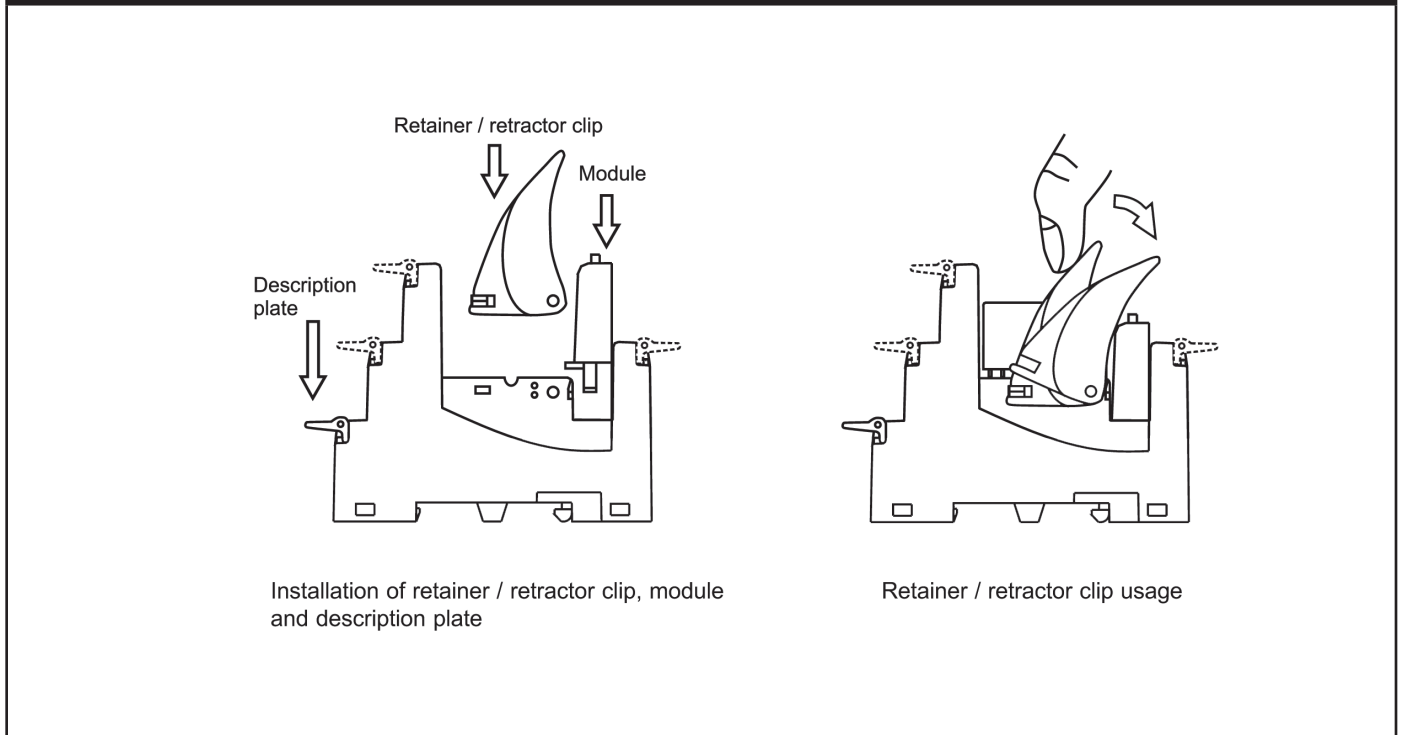

Dimensions are in millimeters (inches). Dimensions not intended for manufacturing purposes.

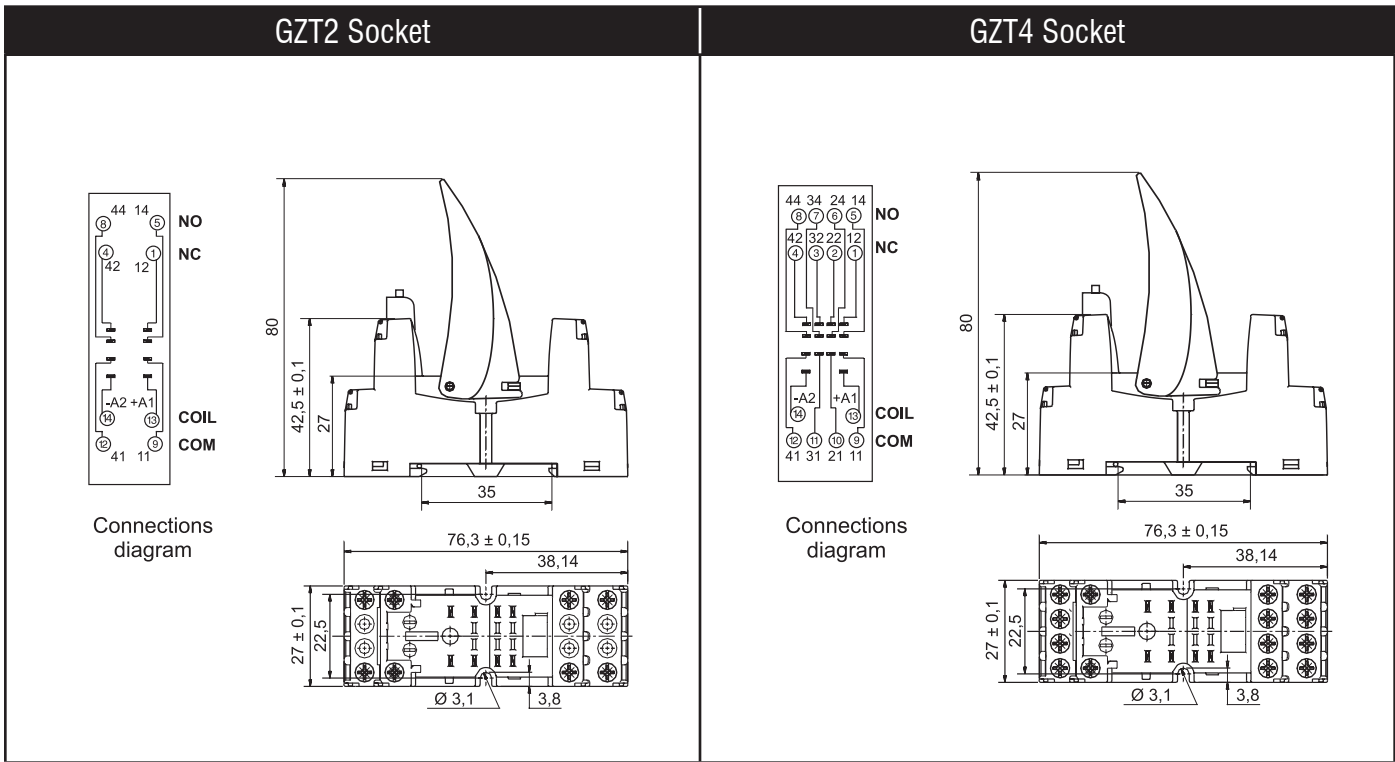

Technical Information
R15

Contacts				
Contact number & arrangement		DPDT, 3PDT		
Contact material		AgNi		
Max. switching voltage	AC/DC	250 V		
Min. switching voltage		5 V AgNi		
Rated load	AC1	10 A / 250 V AC		
	AC15	3 A / 120V	1.5 A / 240 V (B300)	
	AC3	370 W (single-phase motor 1/2 HP / 240 V AC UL 508)		
	DC1	10 A / 24 V DC		
	DC13	0.22 A / 250 V	0.1 A / 250 V (R300)	
Min. switching current		5 mA AgNi		
Max. inrush current		20 A		
Rated current		10 A		
Max. breaking capacity	AC1	2 500 VA		
Min. breaking capacity		0,3 W		
Resistance		≤ 100 mΩ		
Max. operating frequency				
• at rated load	AC1	1 200 cycles/hour		
• no load		12 000 cycles/hour		
General data				
Operating time (typical value)		AC: 12 ms DC: 18 ms		
Release time (typical value)		AC: 10 ms DC: 7 ms		
Electrical life				
• resistive AC1		≥ 2x10 ⁵ 10 A, 250 V AC		
• cosφ		see graphs on page G76		
Mechanical life (cycles)		≥ 2 x 10 ⁷		
Dimensions (L x W x H)		35 x 35x 54,4 mm		
Weight		83 g		
Ambient temperature				
• storing		-40...+85 °C		
• operating		AC: -40...+55 °C DC: -40...+70 °C		
Cover protection category		IP 40		
Shock resistance	(NO/NC)	10 g		
Vibration resistance		5 g 10...150 Hz		
Solder bath temperature		max. 270 °C		
Soldering time		max. 5 s		
Insulation				
Insulation category		C250		
Insulation rated voltage		250 V AC		
Dielectric strength				
• coil - contact		2 500 V AC		
• contact - contact		1 500 V AC		
• pole - pole		2 000 V AC		
Contact - coil distance				
• clearance		≥ 3 mm		
• creepage		4,2 mm		
UL/CSA Ratings				
Contact Ratings, General Purpose		10A - 120 250V AC, 240 VAC		
Pilot Duty Ratings		B300		
Contacts	Inductive	Make	Break	HP
	120VAC	30A	3A	1/3
	240VAC	15A	1.5A	1/2
	DC		10A 28V DC	
UL File Number		E105728		
CSA File Number		LR86957		
Standards		UL 508, CAN/CSA-C22.2 No. 14		

Technical Information
R15

Coil	
Rated voltage	AC: 6...240 V 50/60 Hz DC: 6...110 V
Must release voltage	AC: $\geq 0,15 U_n$ DC: $\geq 0,1 U_n$
Operating range of supply voltage	see coil data tables below
Rated power consumption	AC: 2,8 VA 50 Hz 2,5 VA 60 Hz DC: 1,5 W

Coil Data - AC 50/60 Hz voltage version

Coil Code	Rated Voltage V AC	Coil Resistance ($\pm 10\%$) at 20 °C Ω	Coil Operating Range V AC	
			min. (at 20 °C)	max. (at 55 °C)
5006	6	4,3	4,8	6,6
5012	12	18,5	9,6	13,2
2024	24	75,0	19,2	26,4
5120	120	1 910,0	96,0	132,0
5240	240	7 760,0	192,0	264,0

Coil Data - DC voltage version

Coil Code	Rated Voltage V DC	Coil Resistance ($\pm 10\%$) at 20 °C Ω	Coil Operating Range V DC	
			min. (at 20 °C)	max. (at 55 °C)
1006	6	28	4,8	6,6
1012	12	110	9,6	13,2
1024	24	430	19,2	26,4
1048	48	1 750	38,4	52,8
1110	110	9 200	88,0	121,0

G
 Relpol Control Relays

R15 8-Pin Connection Diagram

(pin side view)

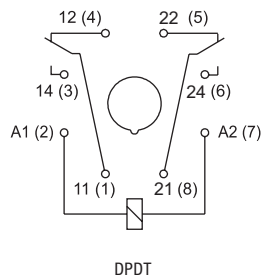
R15 11-Pin Connection Diagram

(pin side view)

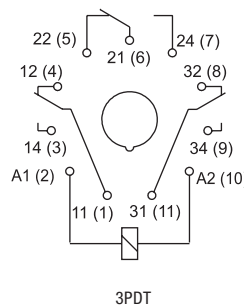

Note:
 Bi-polar input for
 DC versions

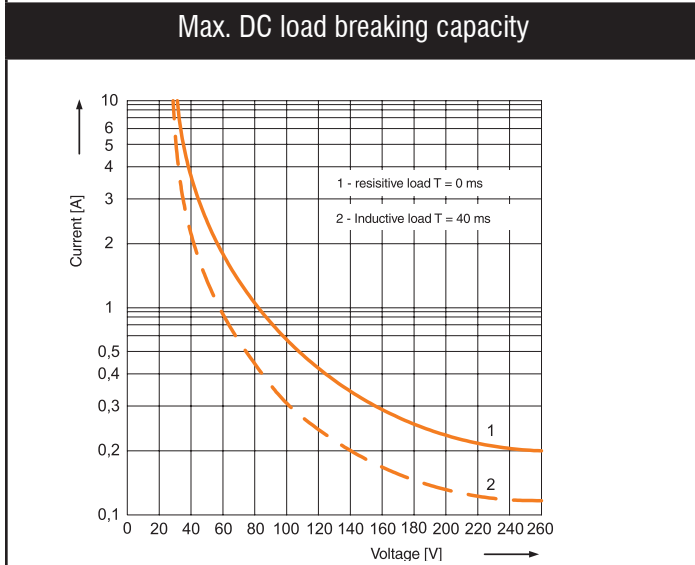
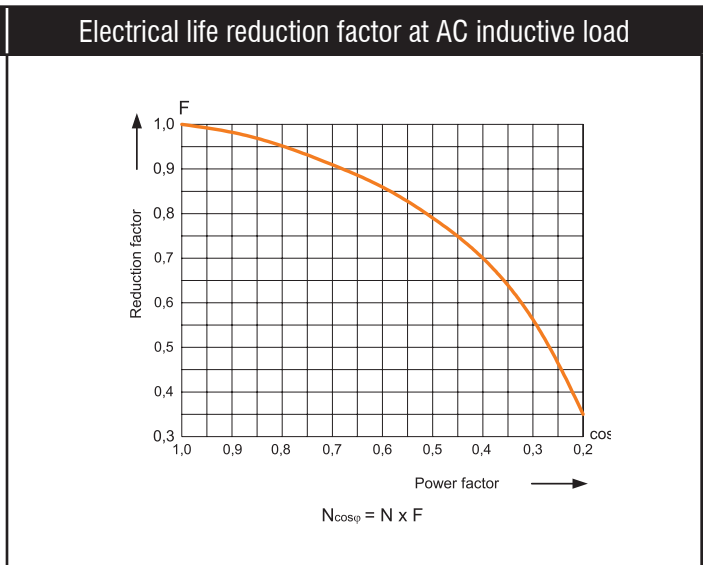
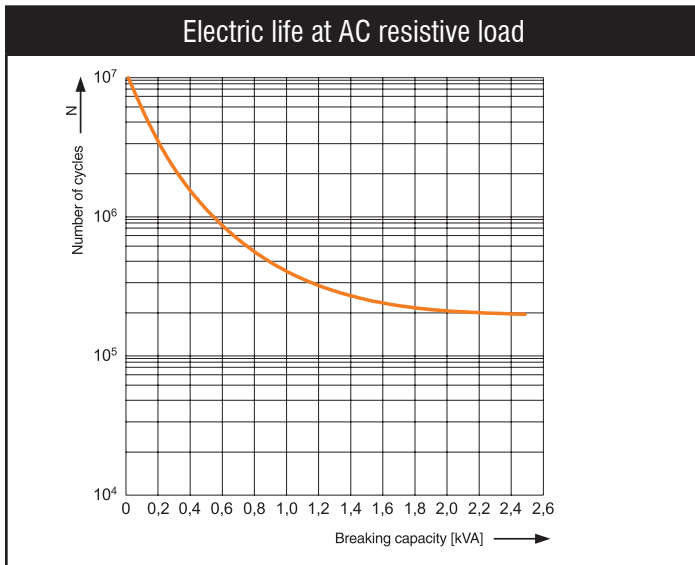

Dimensions are in millimeters (inches). Dimensions not intended for manufacturing purposes.

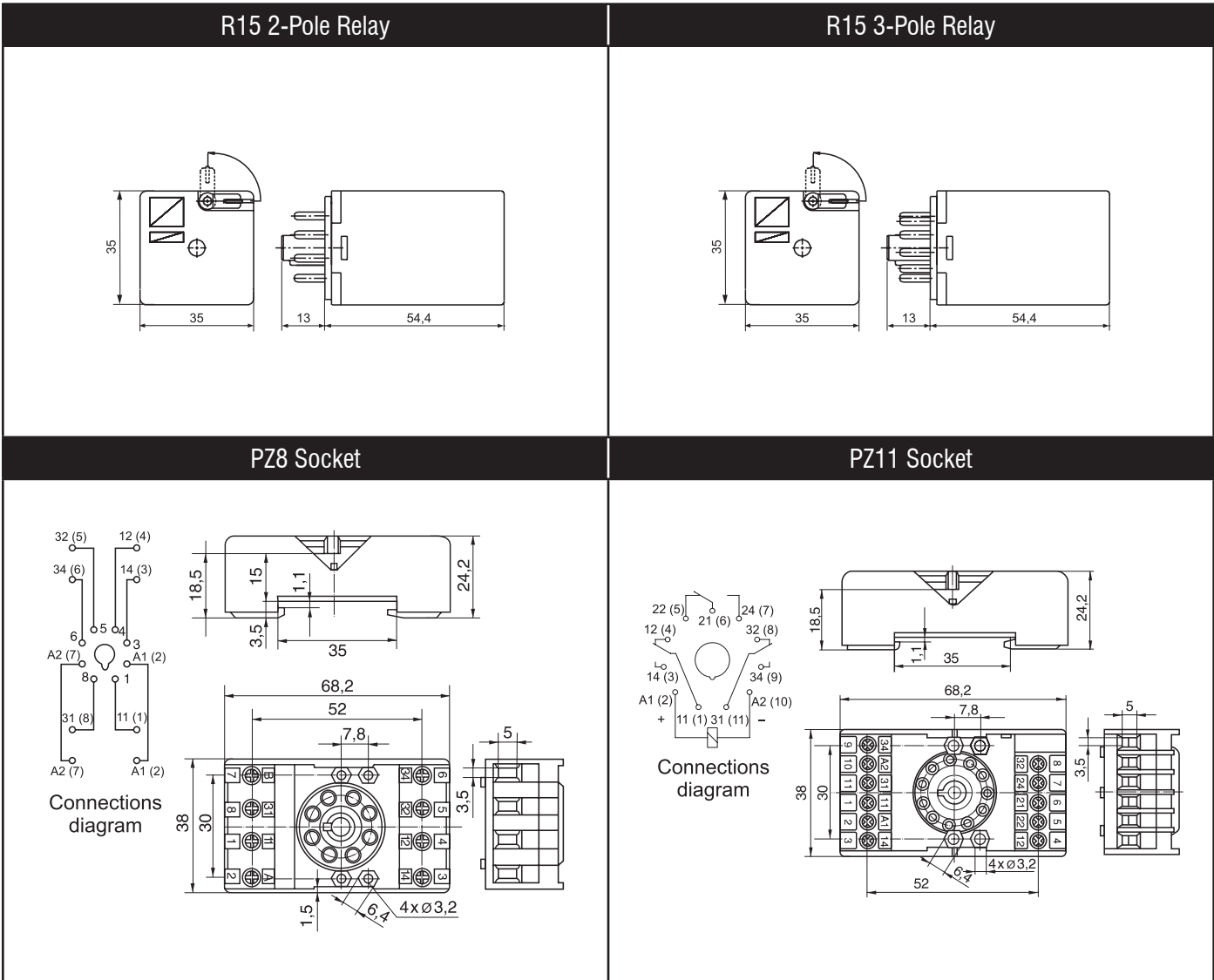

Technical Information

		RUC
Contacts		
Contact number & arrangement		DPDT, 3PDT
Contact material		AgSnO ₂
Max. switching voltage	AC/DC	250 V
Min. switching voltage		10 V
Rated load	AC1	16 A / 250 V AC
	DC1	16 A / 24 V DC
Min. switching current		10 mA
Max. inrush current		40 A
Rated current		16 A
Max. breaking capacity	AC1	4 000 VA
Min. breaking capacity		1 W
Resistance		≤ 100 mΩ
Max. operating frequency		
• at rated load	AC1	1 200 cycles/hour
• no load		12 000 cycles/hour
General data		
Operating time (typical value)		AC: 12 ms DC: 12 ms
Release time (typical value)		AC: 10 ms DC: 7 ms
Electrical life		
• resistive AC1		≥ 10 ⁵ 16 A, 250 V AC
• cos φ		see graphs on page <?>
Mechanical life (cycles)		≥ 10 ⁷
Dimensions (L x W x H)		38,6 x 36,1 x 45,5 mm
Weight		85 g
Ambient temperature		
• storage		-40...+85 °C
• operating	AC	-40...+55 °C 3 C/O, 3 NO / 16A (+70 °C 2 C/O, 2 NO / 16A)
	DC	-40...+55 °C 3 C/O, 3 NO / 16A (+70 °C 3 C/O, 3 NO / 10 A; 2 C/O, 2 NO / 16 A)
Cover protection category		IP 40
Shock resistance (NO/NC)		10 g
Vibration resistance		5 g 10...150 Hz
Solder bath temperature		max. 270 °C
Soldering time		max. 5 s

		RUC
Insulation		
Insulation category		C250
Insulation rated voltage		400 V AC
Dielectric strength		
• coil - contact		2 500 V AC
• contact - contact		1 500 V AC
• contact - contact 3 mm		2 500 V AC
• pole - pole		2 000 V AC
Contact - coil distance		
• clearance / • creepage		≥ 6 mm / ≥ 8 mm
UL/CSA Ratings		
Contact Ratings		DPDT 10A 250 V AC 3PDT 10A 250 V AC
General Purpose Rating		15A 250V (resistive) 10 A 250 V AC 15A 150 V AC
Motor Load according to UL 508	2 C/O:	1/3 HP 120 V AC single-phase motor 1/2 HP 240 V AC single-phase motor
	3 C/O:	1/3 HP 120 V AC single-phase 1/2 HP 240 V AC single-phase motor 1/2 HP 240 V AC three-phase motor
Pilot Duty Ratings		B300
Contacts	Inductive	Make Break HP
	120VAC	30A 3A 1/3
	240VAC	15A 1.5A 1/2
	DC	10A 28V DC
UL File Number		E105728
CSA File Number		LR86957
Standards		UL 508, CAN/CSA-C22.2 No. 14
Coil		
Rated voltage	50/60 HzAC	6...240 V
	DC	6...110 V
Must release voltage		AC: ≥ 0,15 U _n DC: 0,1 U _n
Operating range of supply voltage		see coil data tables below
Rated power	AC	2,8 VA 50 Hz 2,5 VA 60 Hz
consumption	DC	1,5 W / 1,7 W with contact gap ≥ 3 mm

Coil Data - AC 50/60 Hz voltage version

Coil Code	Rated Voltage V AC	Coil Resistance (±10%) at 20 °C Ω	Coil Operating Range V AC	
			min. (at 20 °C)	max. (at 55 °C)
5006	6	4,3	4,8	6,6
5012	12	18,5	9,6	13,2
2024	24	75,0	19,2	26,4
5120	120	1 910	96,0	132,0
5240	240	7 760	192,0	264,0

Coil Data - DC voltage version

Coil Code	Rated Voltage V DC	Coil Resistance (±10%) at 20 °C Ω	Coil Operating Range V DC	
			min. (at 20 °C)	max. (at 55 °C)
1006	6	28	4,8	6,6
1012	12	110	9,6	13,2
1024	24	430	19,2	26,4
1048	48	1 750	38,4	52,8
1110	110	9 200	88,0	121,0

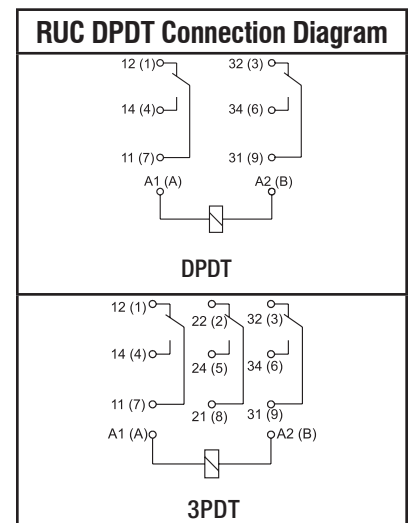

Dimensions are in millimeters (inches). Dimensions not intended for manufacturing purposes.

Electric life at AC resistive load

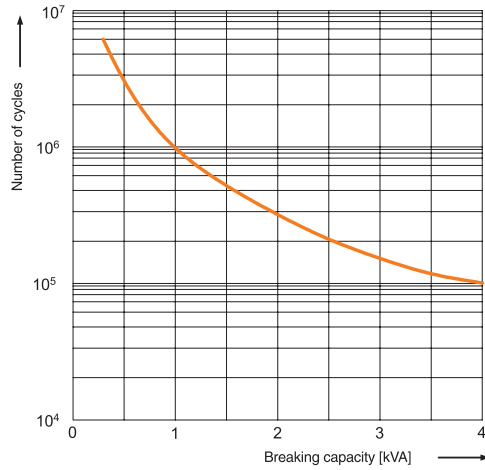

Electrical life reduction factor at AC inductive load

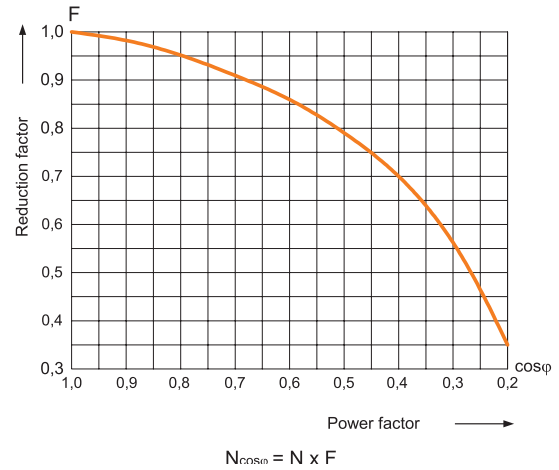

Max. DC load breaking capacity

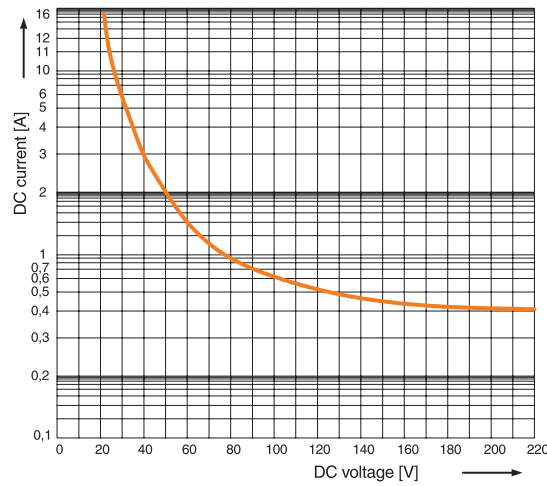

RUC Relay

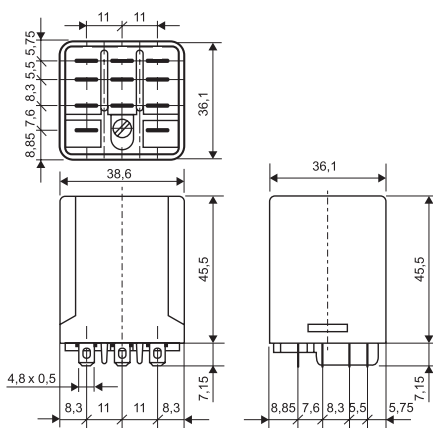

SB11 Socket

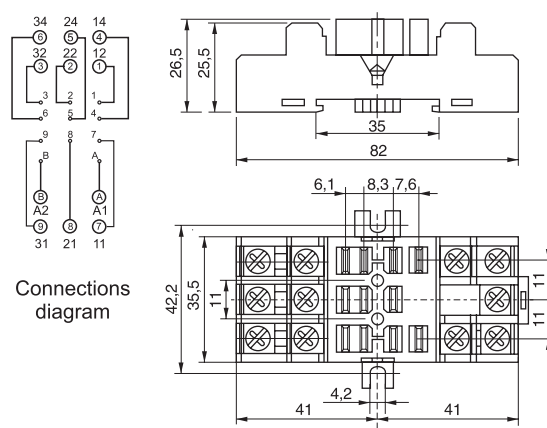

G Relpol Control Relays

Technical Information

		RY2	
Contacts			
Contact number & arrangement		DPDT	
Contact material		RY2-1012 AgCdO / RY2-2012 AgNi	
Max. switching voltage	AC/DC	250 V / 250 V	
Min. switching voltage		AgCdO 10 V / AgNi 5 V	
Rated load	AC1	12 A / 250 V AC	
	DC1	12 A / 30 V DC	
Min. switching current		AgCdO 10 mA / AgNi 5 mA	
Max. inrush current		20 A	
Rated current		12 A	
Max. breaking capacity	AC1	3 000 VA	
Min. breaking capacity		1 W	
Resistance		≤ 100 mΩ	
Max. operating frequency		1 200 cycles/hour	
• at rated load	AC1	18 000 cycles/hour	
• no load			
General data			
Operating time (typical value)		15 ms	
Release time (typical value)		10 ms	
Electrical life			
• resistive AC1		≥ 10 ⁵ 12 A, 250 V AC	
• cos φ		see graphs on page G88	
Mechanical life (cycles)		≥ 10 ⁷	
Dimensions (L x W x H)		27,5 x 21,1 x 34,5 mm	
Weight		35 g	
Ambient temperature			
• storing		-40...+70 °C	
• operating		-40...+55 °C	
Cover protection category		IP 40	
Shock resistance	(NO/NC)	10 g	
Vibration resistance		5 g 15...150 Hz	
Solder bath temperature		max. 270 °C	
Soldering time		max. 5 s	
Insulation			
Insulation category		B250	
Insulation rated voltage		250 V AC	
Dielectric strength			
• coil - contact		2 500 V AC	
• contact - contact		1 500 V AC	
• pole - pole		2 500 V AC	
Contact - coil distance			
• clearance		≥ 2,6 mm	
• creepage		4 mm	
UL/CSA Ratings			
Contact Ratings			
General Purpose Rating		10A 250V AC	
Pilot Duty Ratings		B300	
Contacts	Inductive	Make	Break
	120VAC	30A	3A
	240VAC	15A	1.5A
	DC	10A 28V DC	
UL File Number		E105728	
Standards		UL 508	

Technical Information
RY2

Coil		
Rated voltage	50/60 Hz AC DC	6...240 V 6...110 V
Must release voltage		AC: $\geq 0,2 U_n$ DC: $0,1 U_n$
Operating range of supply voltage		see coil data tables below
Rated power consumption	AC DC	1,6 VA 0,9 W

Coil Data - AC 50/60 Hz voltage version

Coil Code	Rated Voltage V AC	Coil Resistance ($\pm 10\%$) at 20 °C Ω	Coil Operating Range V AC	
			min. (at 20 °C)	max. (at 55 °C)
5006	6	9,8	4,8	6,6
5012	12	39,5	9,6	13,2
2024	24	158,0	19,2	26,4
5120	120	3 770,0	96,0	132,0
5240	240	16 800,0	192,0	264,0

Coil Data - DC voltage version

Coil Code	Rated Voltage V DC	Coil Resistance ($\pm 10\%$) at 20 °C Ω	Coil Operating Range V DC	
			min. (at 20 °C)	max. (at 55 °C)
1006	6	40	4,0	5,5
1012	12	160	9,6	13,2
1024	24	640	19,2	26,4
1048	48	2 600	38,4	52,8
1110	110	13 600	88,0	121,0

RY2 Connection Diagram

(pin side view)

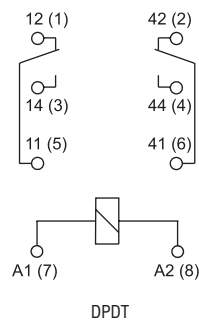
Note: Bi-polar input for DC versions

Electric life at AC resistive load

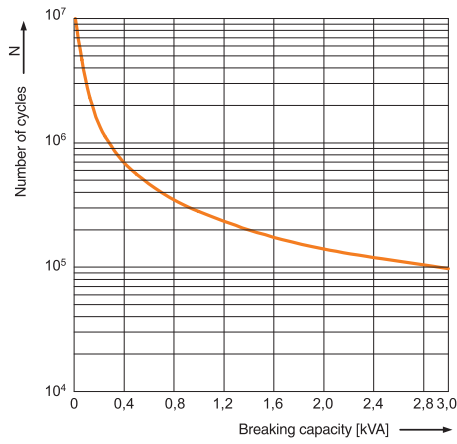

Electrical life reduction factor at AC inductive load

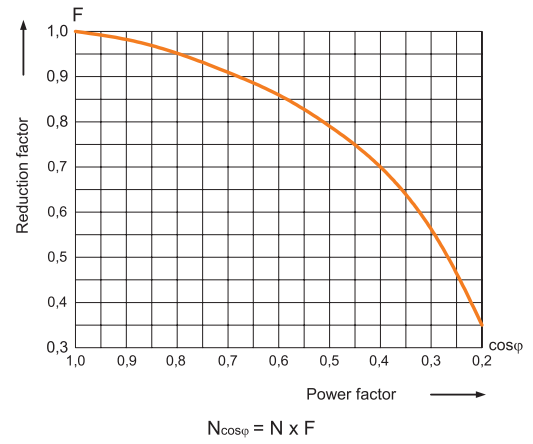

Dimensions

Dimensions are in millimeters (inches). Dimensions not intended for manufacturing purposes.

RY2 Relay

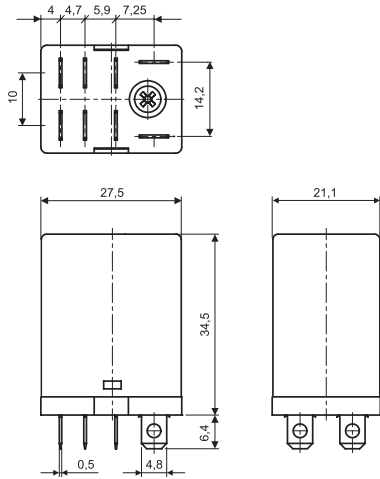

SB08 Socket

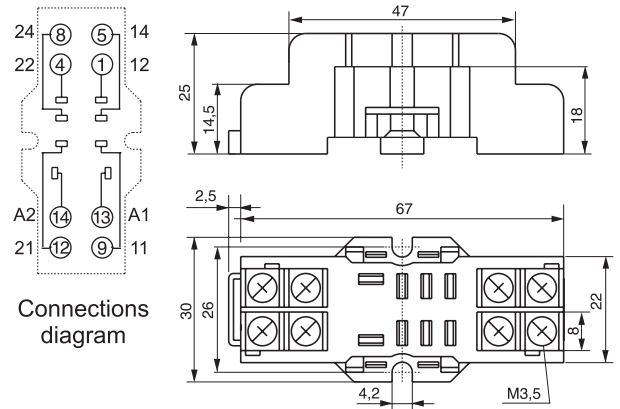

Technical Information

		PI84	PI85
Contacts			
Contact number & arrangement		DPDT	SPDT
Contact material		AgNi	
Max. switching voltage	AC/DC	400 V / 300 V	
Min. switching voltage		5 V	
Rated load	AC1	8 A / 250 V AC	16 A / 250 V AC
	AC15	3 A / 120 V AC	3 A / 120 V AC
		1.5 A / 240 V AC (B300)	1.5 A / 240 V AC (B300)
	AC3	550 W (single-phase motor)	750 W (single-phase motor)
	DC1	8 A / 24 V DC	16 A / 24 V DC
DC13		0.22 A / 120 V DC	0.22 A / 120 V DC
		0.1 A / 250 V DC (R300)	0.1 A / 250 V DC (R300)
Min. switching current		5 mA	
Max. inrush current		15 A	30 A
Rated current		8 A	16 A
Max. breaking capacity	AC1	2 000 VA	4 000 VA
Min. breaking capacity		0,3 W	
Resistance		≤ 100 mΩ	
Max. operating frequency	AC1	600 cycles/hour	
		172 000 cycles/hour	
General data			
Operating time (typical value)		7 ms	
Release time (typical value)		3 ms	
Electrical life		> 10 ⁵ 8 A, 250 V AC	≥ 0.7 x 10 ⁵ 16 A, 250 V AC
• resistive AC1		see graphs on page 94	
• cos φ		≥ 3 x 10 ⁷	
Mechanical life (cycles)		75,3 x 15,5 x 67 mm	
Dimensions (L x W x H)		62 g	
Weight		Ambient temperature	
Ambient temperature		-40...+85 °C	
• storing		AC: -40...+70 °C DC: -40...+85 °C	
• operating		Protection category	
Protection category		• cover IP 40	
• cover		• terminals IP 20	
• terminals		20 g	30 g
Shock resistance		Vibration resistance (NO/NC)	
Vibration resistance (NO/NC)		10 g / 5 g	
Insulation			
Insulation category		G250	
Insulation rated voltage		400 V AC	
Dielectric strength	• coil - contact	5 000 V AC	
	• contact - contact	1 000 V AC	
	• pole - pole	2 500 V AC	
Contact - coil distance		≥ 10 mm	
• clearance		≥ 10 mm	
• creepage			

Technical Information

		PI84	PI85
Coil			
Rated voltage	50/60 Hz AC DC		24-120 V 24V
Must release voltage		AC: $\geq 0,15 U_n$ DC: $0,1 U_n$	
Operating range of supply voltage		see Table 1, 2 and Fig. 4, 5	
Rated power consumption	AC DC		0,75 VA 0,4...0,48 W

Coil Data - AC 50/60 Hz voltage version

Coil Code	Rated Voltage V AC	Coil Resistance ($\pm 10\%$) at 20 °C	Coil Operating Range V AC	
			min. (at 20 °C)	max. (at 55 °C)
24AC	24	400	19,2	26,4
120AC	120	10 200	96,0	144,0

Coil Data - DC voltage version

Coil Code	Rated Voltage V DC	Coil Resistance ($\pm 10\%$) at 20 °C	Coil Operating Range V DC	
			min. (at 20 °C)	max. (at 55 °C)
24DC	24	1 440	16,8	61,2

PI84 Connection Diagram

(pin side view)

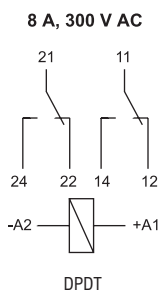

PI85 Connection Diagram

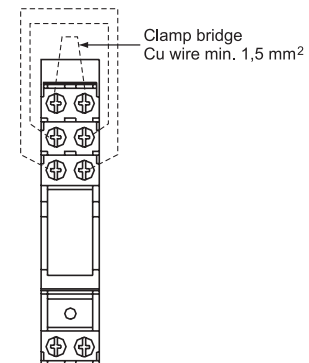
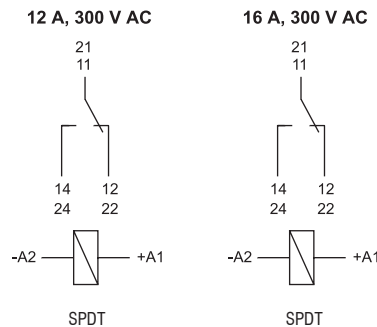
(pin side view)

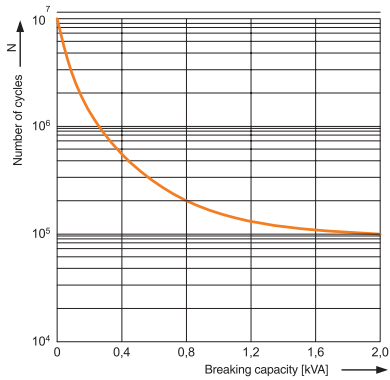

Note: Loads above 12 A require bridging pairs of terminals: 11 with 21, 12 with 22, 14 with 24. Loads up to 12 A do not require bridging of common terminals (such bridges may be fixed, however)

Electrical life at AC resistive load



Electrical life reduction factor at AC inductive load

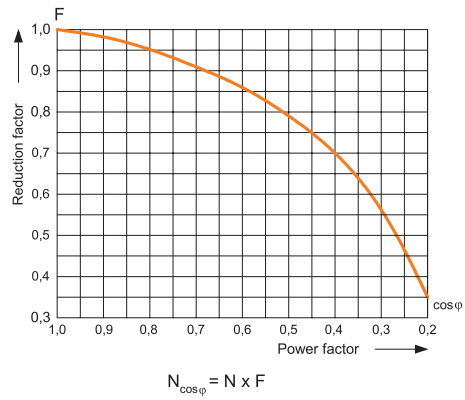

Max. DC resistive load breaking capacity

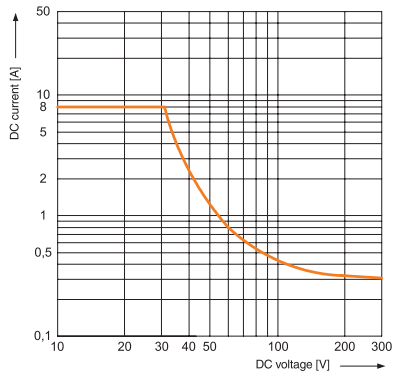

Coil operating range - DC

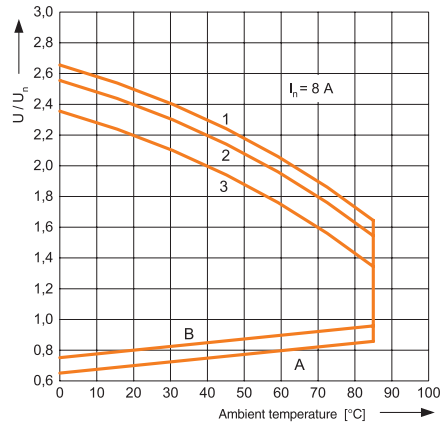

Coil operating range - AC

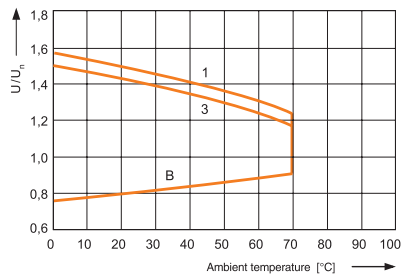

G
Relpol Control Relays

Electrical life at AC resistive load

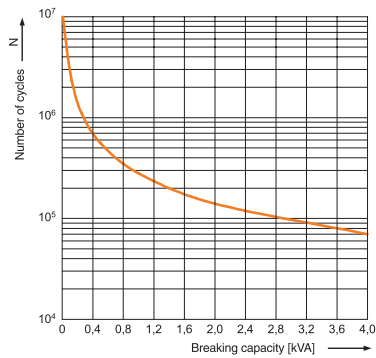

Electrical life reduction factor at AC inductive load

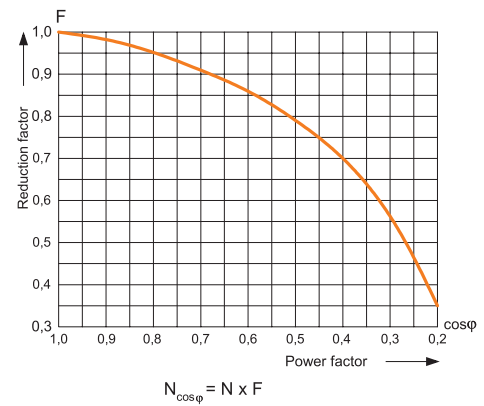

Max. DC resistive load breaking capacity

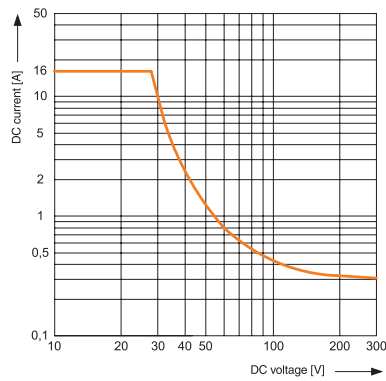

Coil operating range - DC

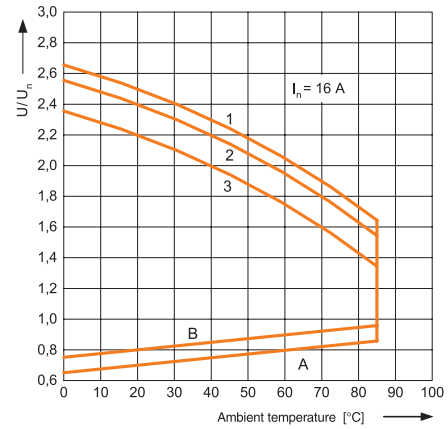

Coil operating range - AC

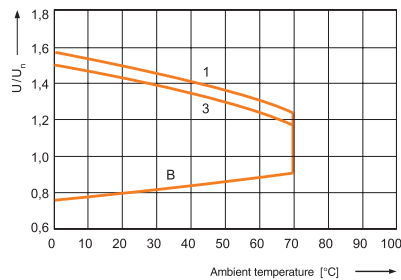

Dimensions are in millimeters (inches). Dimensions not intended for manufacturing purposes.

PI84/PI85 Interface Relay and Socket

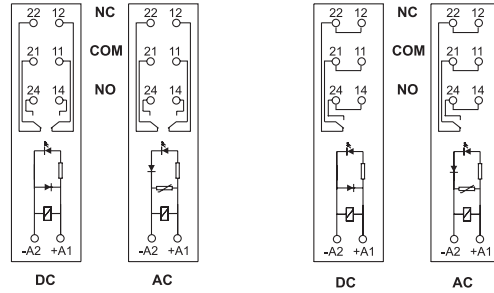
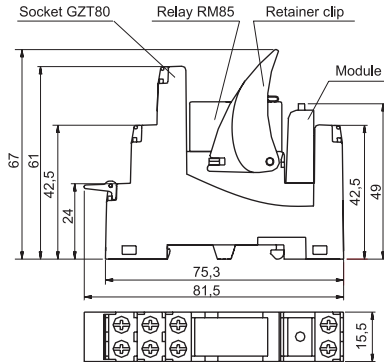

RM84/RM85 Replacement Relay

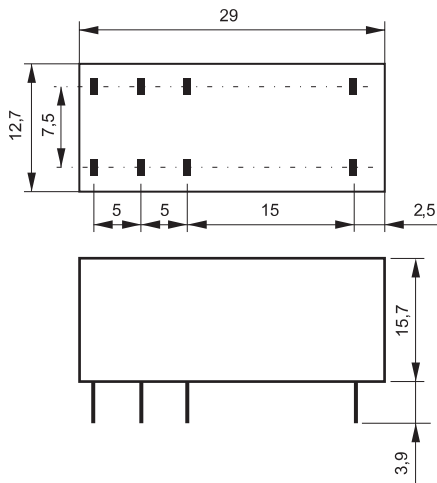

RM84

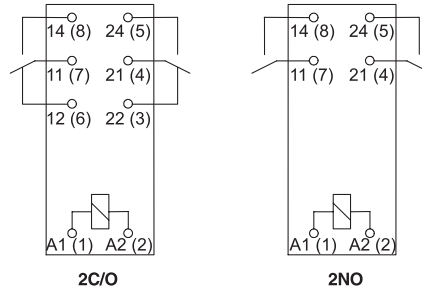

RM85

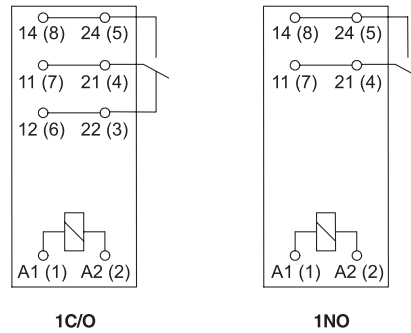

Terminal (pin)	A1(1); A2(2)	22(3); 21(4); 24(5); 12(6); 11(7); 14(8)
mm	φ 0,6	0,5 x 0,9
Drilling hole	for relays φ 1,3 mm ± 0,1 for sockets φ 1,5 mm ± 0,1	

Contacts

Contact number & arrangement	1 C/O	
Contact material	AgSnO₂	
Max. switching voltage	AC/DC	AgSnO ₂ : 250 V / 400 V AC/ 125 V DC
Min. switching voltage	AC/DC	AgSnO ₂ : 10 V
Rated load	AC1	AgSnO ₂ : 6 A / 250 V AC
	DC1	AgSnO ₂ : 6 A / 24 V DC
Min. switching current	AgSnO ₂ : 100 mA / 24 V	
Max. inrush current (20 ms)	AgSnO ₂ : 10 A	
Rated current	6 A	
Max. breaking capacity	AC1	AgSnO ₂ : 1 500 VA
Min. breaking capacity	AgSnO ₂ : 1 W	
Resistance - initially	AgSnO ₂ : ≤ 100mΩ 100 mA, 24 V	
Max. operating frequency		
• at rated load	AC1	360 cycles/hour
• no load		72 000 cycles/hour

Input control circuit

Rated voltage	DC	12-24 V
	AC/DC	24-115 V AC:50/60 Hz
Must release voltage	AC: ≥ 0,2 U _n	
	DC: ≥ 0,1 U _n	
Operating range of supply voltage	see Table 1	
Must operate voltage	AC and DC: ≤ 0,8 U _n	
Rated power consumption	AC/DC	0.3...2.1 VA / 0.3...1.0W
	DC	0.3 W

Insulation

Insulation RATED VOLTAGE	250 V AC (PN-EN 60664-1)	
Rated surge voltage	4 000 V AC 1.2 / 50 μs	
Oversvoltage category	III IEC 61810-52 (PN-IEC 664-1)	
Insulation pollution degree	3	
Dielectric strength		
• input - output	4 000 V AC	50/60 Hz, 1 min., type of insulation: reinforced
• input - output	6 000 V	1.2 / 50 μs, surge voltage
• input - output	2 500 V AC	50/60 Hz 1 min.
• contact clearance	1 000 V AC	50/60 Hz 1 min., type of clearance: micro-disconnection
Input-Output - coil distance		
• clearance	≥ 6 mm	
• creepage	≥ 8 mm	

General data

Operating time (typical value)	AC: 11 ms	DC: 8 ms
Release time (typical value)	AC: 15 ms	DC: 10 ms
Electrical life		
• resistive AC1	360 cycles/hour	> 0,6 x 10 ⁵ 6 A, 250 V AC
• cos φ = 0,4		> 2 x 10 ⁵ 2 A, 250 V AC
Mechanical life (cycles)	> 2 x 10 ⁷	
Dimensions (L x W x H)	98.5 x 6.2 x 85.5 mm	
Weight	45g	
Ambient temperature		
• storage	-40...+70 °C	
• operating	-40...+55 °C	-40...+60 °C 12,24 V DC
Protection category	IP 20, PEN-EN 60529	
Environmental protection	RTI, PEN-EN 116000-3	
Shock resistance	10 g	
Vibration resistance	5 g 10...500 Hz	

① Standard contact materials and coil rated voltages are marked with bold type.

Input Data

Relay code	Nominal input voltage U_n	Input power control circuit (U_p)	Input - voltage range V	
			min.	max.
PIR6W-1P-12VDC	12 V DC	0,3 W	9,6	14,14
PIR6W-1P-24VDC	24 V DC	0,3 W	19,2	28,0
PIR6W-1P-24VAC/DC	24 V AC/DC	0,3 VA / 0,3 W	19,2	26,4
PIR6W-1P-115VAC/DC	115 V DC	0,9 VA / 0,9 W	92,0	130,0

Connection Diagrams

PIR6W-1P-12VDC
PIR6W-1P-24VDC

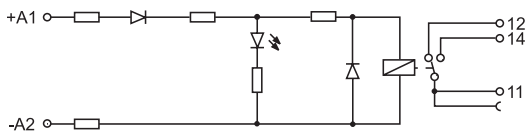

PIR6W-1P-24VAC/DC

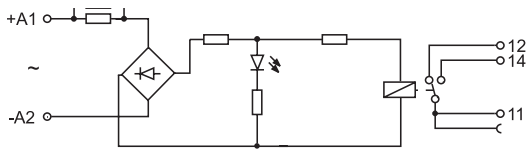

PIR6W-1P-115VAC/DC

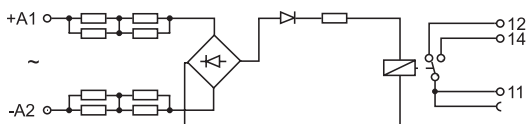

Dimensions

Dimensions are in millimeters (inches). Dimensions not intended for manufacturing purposes. ①

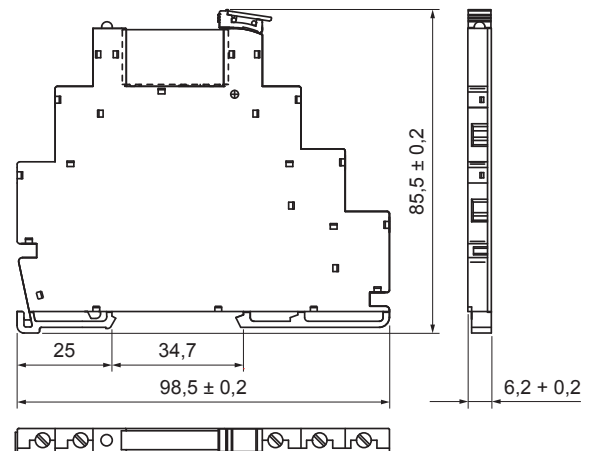

Interconnection Strip ZG20

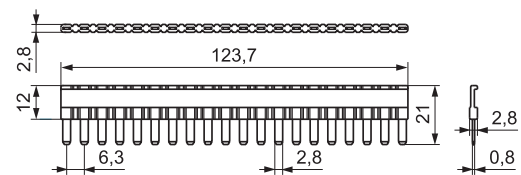

Description Plate PI6W-1246

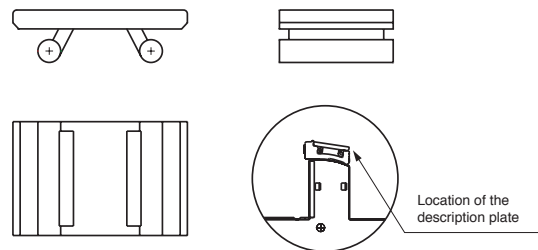

Mounting

Relays **PIR6W** are designed for 35 mm DIN rail mount, EN 50022.

PIR6W are adapted for the co-operation with interconnection strip type **ZG20**. Interconnection strip **ZG20** allows to common bridging outputs or inputs. Maximum current rate is 36 A. Colors of strips: **ZG20-1** red, **ZG20-2** black, **ZG20-3** blue.

① In March 2016, Relpol changed the DIN-rail fixing place location as represented in this view.

Electrical life at AC resistive load.
Maximum switching frequency at rated load

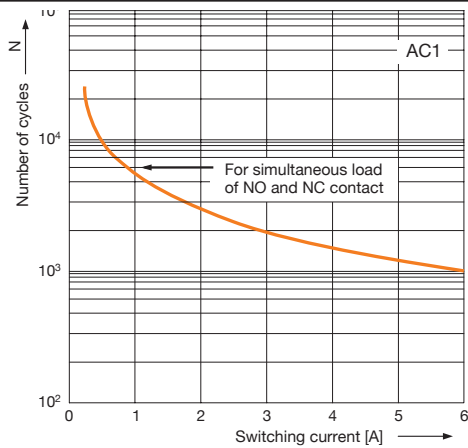

Max. DC resistive load breaking capacity

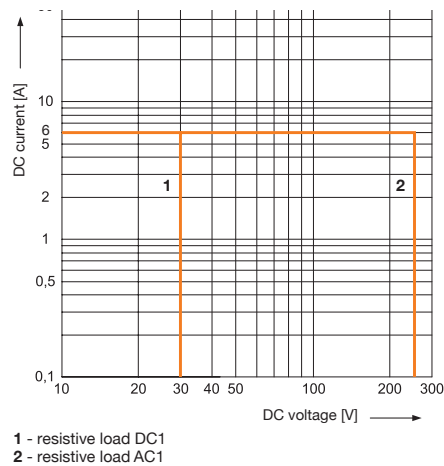

Coil Operating Range - DC

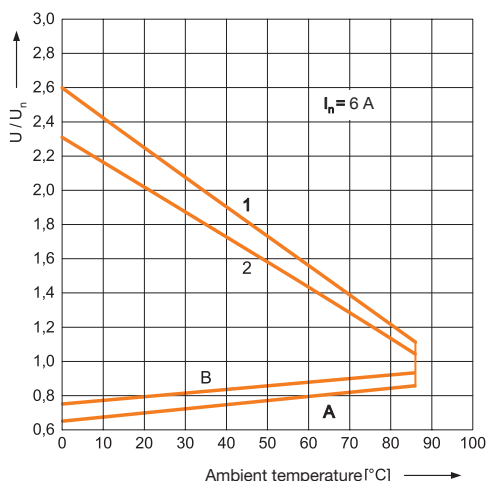

RM699 Interface Operational Relay
Dimensions

Dimensions are in millimeters (inches). Dimensions not intended for manufacturing purposes.

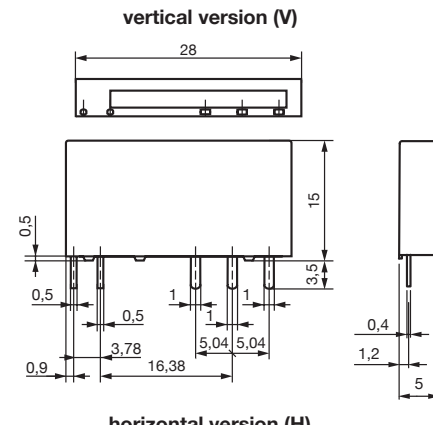

RM699 Connections Diagrams (pin side view)

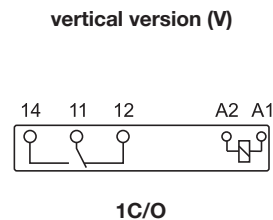

RM699 Mounting openings raster (solder side view)

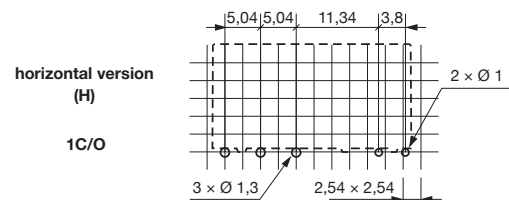

Description of Coil Operating Range

A - relations between make voltage and ambient temperature at no load on contacts. Coil temperature and ambient temperature are equal before coil energizing. Make voltage is not higher than the value read on Y axis (multiplication of rated voltage).

B - relations between make voltage and ambient temperature after initial coil heating up with 1,1 Un, at continues load of In on contacts. Make voltage is not higher than the value read on Y axis (multiplication of rated voltage).

1, 2,3 - values on Y axis represent allowed overvoltage on coil at certain ambient temperature and contact load:

- 1 - no load
- 2 - rated load